

PrimeVOLT

User Manual

Applicable model: 7K/8K/10K



Contents

Forward

- Application Model
- Intended Audience
- Symbol Conventions

1 Safety Precautions

- 1.1 Personnel Safety
- 1.2 The PV Inverter Protection
- 1.3 Installation Safety
- 1.4 Electrical Connections
- 1.5 Operating and Commissioning
- 1.6 Maintenance
- 1.7 Additional Information

2 Overview

- 2.1 Functional Models
- 2.2 Network Application
- 2.3 Outline and Dimensions
- 2.4 Working Process
- 2.5 Working Modes

3 Storage

4 Installation

- 4.1 Checking the Outer Packing
- 4.2 Moving the inverter
- 4.3 Identify the PV Inverter
- 4.4 Installation Requirements
- 4.5 Installing a Rear Panel
- 4.6 Installing the Inverter

5 Electrical Connections

- 5.1 Connecting Protection Ground (PGND) Cables
- 5.2 Connecting AC Output Cables
- 5.3 Connecting the PV Strings
- 5.4 Connecting Communication Cables
- 5.5 Power limit (optional)
- 5.6 Installation Verification

6 System Operation

- 6.1 Powering ON the Inverter
- 6.2 Powering OFF the Inverter

7 User Interface

- 7.1 HMI specification definition
- 7.2 LCD is automatic page turning display

8 Maintenance

- 8.1 Routine Maintenance
- 8.2 The Inverter Troubleshooting
- 8.3 Removing the Inverter

9 Disposal of the Inverter

10 Technical Specifications

Forward

This user manual introduces the inverter in terms of its installation electrical connections, operation, commissioning, maintenance, and troubleshooting. Please read through the manual carefully before installing and using the inverter, and keep the manual well for future reference.

Application Model

PV 7KTL-D1P is abbreviated as 7K. The models are abbreviated in the following paragraphs.
Grid-tied PV string inverter

- 7K
- 8K
- 10K

Intended Audience







This user manual is intended for photovoltaic (PV) inverter operating personnel and qualified electrical technicians.

Notes:

This user manual is subject to change (specific please in kind prevail) without prior notice.

Symbol Conventions

Safety symbols used in this manual, which highlight potential safety risks and important safety information, are listed as follows:

Symbol	Description
 DANGER	Indicates an imminently hazardous situation which, if not correctly followed, will result in serious injury or death.
 WARNING	Indicates a potentially hazardous situation which, if not correctly followed, could result in serious injury or death.
 CAUTION	Indicates a potentially hazardous situation which, if not correctly followed, could result in moderate or minor injury.
 NOTICE	Indicates a potentially hazardous situation which, if not correctly followed, could result in equipment failure to run or property damage.
 NOTE	Calls attention to important information best practices and tips: supplement additional safety instructions for your better use of the PV inverter to reduce the waste of your resource.
 REFER	Refer to documentation (Remind operators to refer to the documentation shipped with the inverter).

1 Safety Precautions

Before beginning your journey, please read these safety precautions in the User Manual carefully.

1.1 Personnel Safety

- a. The PV inverter must be installed, electronically connected operated and maintained through specially trained technician;
- b. The qualified technician must be familiar with the safety regulations of electrical system, working process of PV power generation system, and standards of local power grid;
- c. The technician must read through this User Manual carefully and master it before any operation.

1.2 PV Inverter Protection



NOTICE

As soon as receiving the PV inverter, please check if it is damaged during its transportation. If yes, please contact your dealer immediately.

- a. Do not tamper with any warning signs on the inverter enclosure because these signs contain important information about safe operation.
- b. Do not remove or damage the name plate on the inverter's enclosure because it contains important product information.

1.3 Installation Safety



NOTICE

Please read the User Manual carefully before installing the PV inverter; warranty or liability will be void from our company if damage is caused by installation faults.



- a. Ensure there is no electrical connections around ports of the PV inverter before installing;
- b. Adequate ventilation must be provided for inverter installation location. Mount the inverter in vertical direction, and ensure that no object is put on the heat sink affecting the cooling. (For details, refer to Chapter 4 Installation)

1.4 Electrical Connections

 DANGER	<p>Before installing the inverter, check all electrical ports to ensure no damage and no short circuit. Otherwise personal casualty and/or fire will occur.</p>
---	---

- a. Input terminals of the PV inverter apply only to input terminals of PV String; do not connect any other DC source to the input terminals.
- b. Before connecting PV modules ensure that its voltage is within the safe range; when exposed to any sunlight, PV modules can generate high voltage.
- c. All electrical connections must meet the electrical standards of the country or region.
- d. Cables used in electrical connections must be well fixed, good insulation, and with appropriate specification.

1.5 Operating and Commissioning

 DANGER	<p>While the inverter operating high voltage can lead to an electrical shock hazard and even cause personal casualties. Therefore operate the PV inverter strictly according to the safety precautions in the user manual.</p>
 WARNING	<p>When the PV array is exposed to light, it supplies a d.c. voltage to the PCE.</p>

- a. Before getting the permission of electrical power sector in the country/region the grid-tied PV inverter cannot start generate power.
- b. Follow the procedures of commissioning described in the user manual when commissioning the PV inverter.
- c. Do not touch any other parts' surface except the DC switch when the PV inverter is operating; its partial parts will be extremely hot and can cause burns.

1.6 Maintenance

 DANGER	<p>Power OFF all electrical terminals before the inverter maintenance; strictly comply with the safety precautions in this document when operating the inverter.</p>
---	--

- a. For personal safety, maintenance personnel must wear appropriate personal protective equipment (like insulation gloves and protective shoes) for the inverter maintenance.
- b. Place temporary warning signs or erect fences to prevent unauthorized access to the maintenance site.
- c. Follow the procedures of maintenance stipulated in the manual strictly.
- d. Check the relevant safety and performance of the inverter rectify any faults that may compromise the inverter security performance before restarting the inverter.

1.7 Additional Information



NOTICE

To avoid any other unforeseeable risk, contact your dealer immediately, if there is any issue found during operation.



2 Overview

This chapter introduces the inverter and describes its functional model, network application, appearance, dimensions and working process etc.

2.1 Functional Models

2.1.1 Function

This series is a single-phase grid-tied PV string inverter (transformer less) that converts the DC power generated by PV strings into AC power and feeds the power into power grid.

 WARNING	The inverter is transformer less. Add an isolation transformer before grounding the positive negative terminal of PV modules (like Thin Film module) for operation.
 WARNING	Do not connect PV modules in parallel to several PV inverters for operation.

2.1.2 Model Description

Figure2.1 shows a model number of the inverter, using 8K as an example.

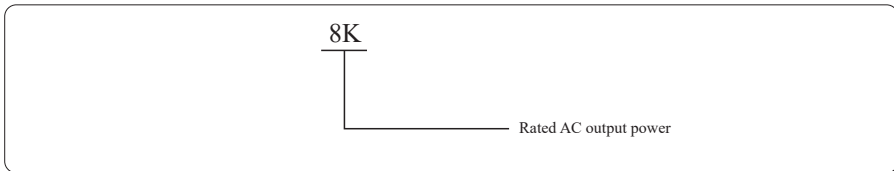

Figure2.1 Model number descriptions

2.2 Network Application

2.2.1 Grid-tied PV Power Systems

The series applies to grid-tied PV power systems for outdoor power stations. Typically, a grid-tied PV power system consists of PV modules, grid-tied inverters, AC distribution units, and low-voltage power grid, as shown in Figure 2.2.

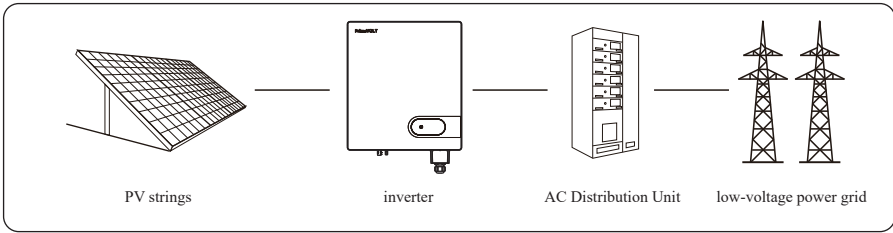

Figure2.2 a low-voltage grid-tied PV power system

Inverters have been tested as per AS/NZS 4777.2:2020 for three phase combinations.

2.3 Outline and Dimensions

2.3.1 Outline

Figures2.3 to 2.7 show the outline of the inverters as follows:

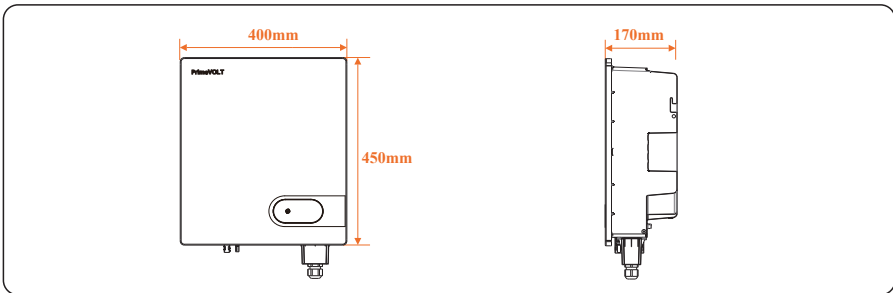

Figure2.3 The outline and dimensions of the Inverter (unit: mm)

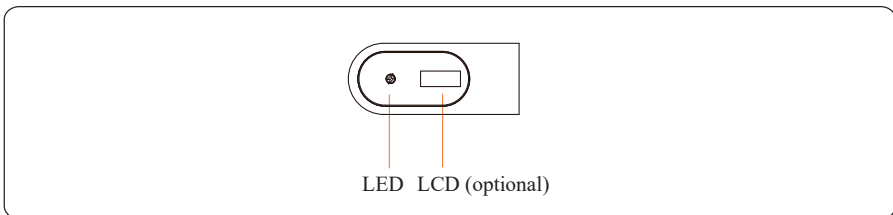

Figure2.4 The front view and amplification effect of LED indicator area

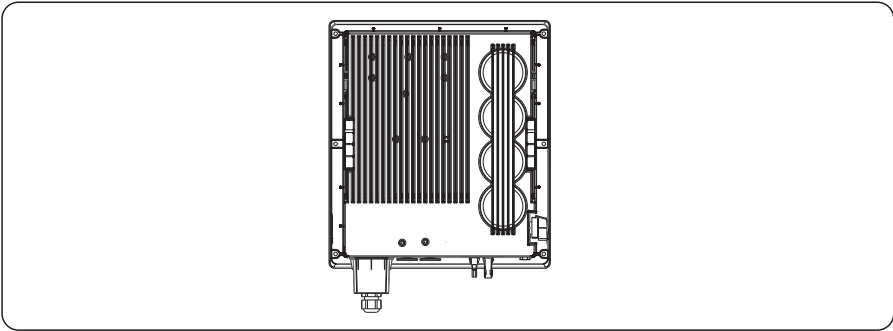

Figure2.5 The rear view of this series inverter

7K

- 1. DC isolation switch
- 2. Vent valve
- 3. PV input connectors (2String)
- 4. COM2(RS-485/meter/CT/DI)
- 5. COM1(WIFI/GPRS/Ethernet/ RS-485)
- 6. AC output connector
- 7. External protection ground interface

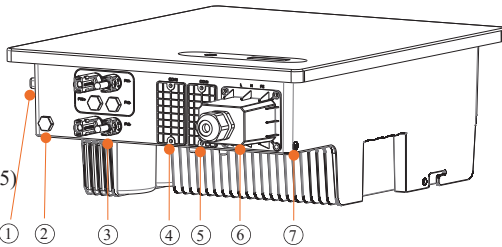

Figure2.6 The bottom view of this series inverter

8K/10K

- 1. DC isolation switch
- 2. Vent valve
- 3. PV input connectors (3String)
- 4. COM2(RS-485/meter/CT/DI)
- 5. COM1(WIFI/GPRS/Ethernet/ RS-485)
- 6. AC output connector
- 7. External protection ground interface

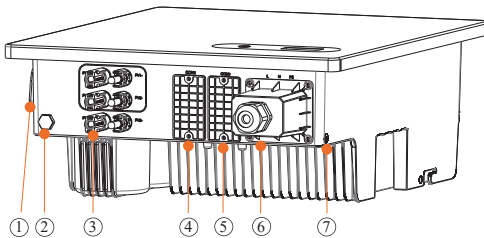

Figure2.7 The bottom view of this series inverter

2.4 Working Process

2.4.1 Basic principle Description

7-10K receive inputs from PV strings through DC switch and surge protection in order: there are 2 groups of PV strings input terminals on DC input terminal of 7K there are 3 groups of PV strings input terminals on 8-10K with the 1st and 2nd routes terminals merging into one independent MPPT. Then the inputs are grouped into two MPPT routes inside the inverter to track the maximum power point of the PV strings. These two MPPT power is then converted into DC Bus which is then converted to AC power through an inverter circuit. Finally the converted AC power is fed to the Power grid through the inverter. Surge protection and EMI filer are supported on both the DC and AC sides to reduce electromagnetic interference.

2.4.2 Circuit Diagrams

Figure 2.9 shows the circuit diagram for the 7K PV Inverter:

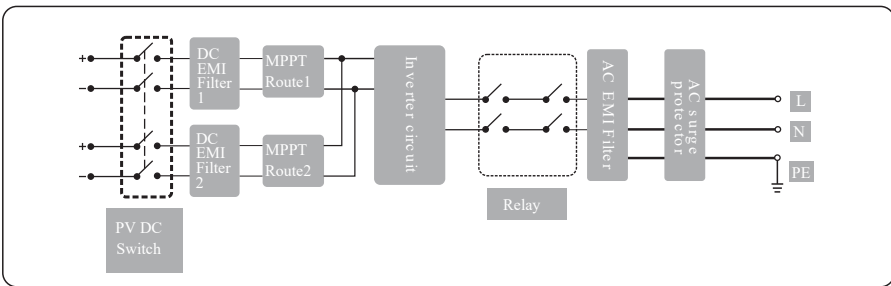

Figure 2.9 circuit diagram

Figure 2.10 shows the circuit diagram for the 8-10K PV Inverter:

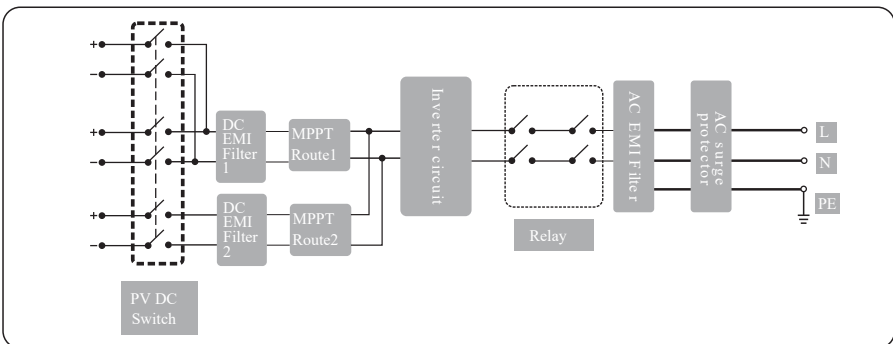

Figure 2.10 circuit diagram

2.5 Working Modes

Three working modes of the inverter are shown as follows: standby, operating and shut down.

Table 2.1 shows the conditions for the inverter to switch between working modes.

Modes	Description
Standby	<p>The PV inverter enters the standby mode when</p> <ul style="list-style-type: none"> > the input voltage of PV Strings can enable auxiliary power supply to run but cannot meet the inverter operation requirements. > the input voltage of PV Strings can meet the inverter to-start requirements, but cannot meet its minimum power requirements.
Operating	<p>When the PV inverter is grid-tied and generate selectricity, it</p> <ul style="list-style-type: none"> > tracks the maximum power point to maximize the PV String output. > converts DC power from PV strings into AC power and feeds the power to the power grid. <p>The PV inverter will enter to the shutdown mode if detecting a fault or a shutdown command.</p>
Shutdown	<p>The PV inverter switches from standby or operating mode to shutdown mode if detecting a fault or a shutdown command.</p> <p>The inverter switches from shutdown mode to standby mode if receiving a Startup command or detecting that a fault is rectified.</p>

Table2.1 Working modes description

 NOTICE	<p>Instructions that if the equipment is used in a manner not specified by the manufacturer, the protection provided by the equipment may be impaired.</p>
---	--



3 Storage

This chapter describes the storage requirements for the inverter.

The following storage instructions apply if the PV inverter will not be deployed immediately:

- > Do not unpack the inverter (put desiccant in the original box if the PV inverter is unpacked).
- > Store the PV inverter at a temperature range of -25°C to $+60^{\circ}\text{C}$ and with the relative humidity of 0% to 100% (no condensing).
- > The PV inverter should be stored in a clean and dry place and be protected from dust and water vapor corrosion.
- > The PV inverter a maximum of six layers of inverters can be stacked.
- > Do not position the inverter at a front tilt excessive back tilt or side tilt, or upside down.
- > Conduct periodic inspection during storage. Replace the packing materials immediately if any rodent bites are found.
- > Ensure that qualified personnel inspect and test the inverter before use if it has been stored for a long time.

4 Installation

 DANGER	Do not install the inverter on flammable building materials or in an area that stores flammable or explosive materials.
 CAUTION	Do not install the inverter in a place where personnel are likely to come into contact with its enclosure and heat sinks to avoid electrical shock/burn.

Inverters have been tested as per AS/NZS 4777.2:2020 for three phase combinations.

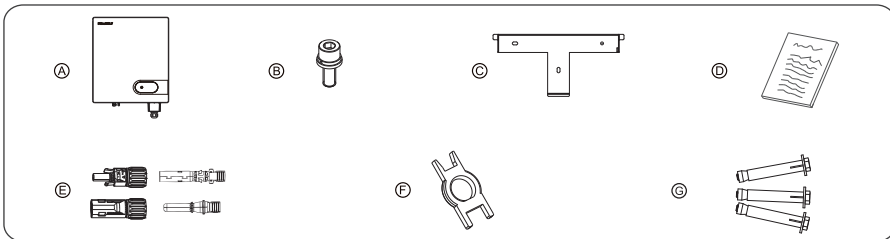

4.1 Checking the Outer Packing

- a. When receiving the inverter check that the packing materials are intact.
- b. After unpacking, check that the deliverables are complete, intact, and consistent with your order list.
- c. Examine the PV inverter and its fittings for damage such as scraps and cracks.



Items	Deliverables
A	The inverter
B	M6 Screw
C	Rear panel
D	File package
E	PV terminal connector group
F	Removal tool for DC connector
G	Expansion screws (reserved for tightening the rear panel)

Figures4.1 The deliverables: The inverter and its fittings

 NOTICE	If any damage mentioned above is found, contact the dealer immediately.
 NOTICE	PV modules for non-isolated inverters. Non-isolated inverters shall be provided with installation instructions that require PV modules that have an IEC 61730 Class A rating. If the maximum AC mains operating voltage is higher than the PV array maximum system voltage then the instructions shall require PV modules that have a maximum system voltage rating based upon the AC mains voltage.

4.2 Moving the inverter

After checking the outer packing, move the PV inverter to the designated installation position horizontally. Hold the handles on both sides of the inverter, as shown in Figure 4.2.

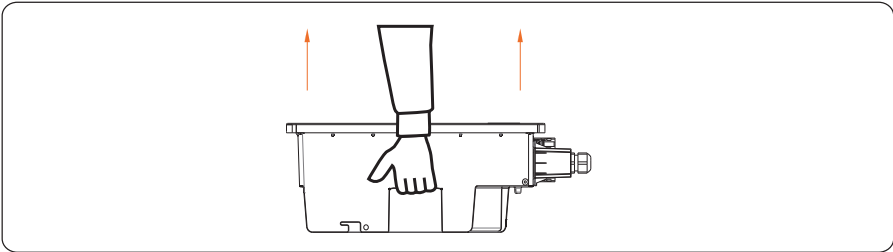



Figure 4.2 Moving the inverter





 CAUTION	<ul style="list-style-type: none"> > Do not place the PV inverter with its wiring terminals contacting the floor because the power ports and signal ports at the bottom of the device are not designed to support the weight of the inverter. > When placing the inverter on the floor horizontally, put foam or paper under to protect its enclosure.
---	--

4.3 Identify the PV Inverter

4.3.1 Nameplate

After moving the PV inverter from packing box, identify it by reading its nameplate labeled on the side of the inverter. The nameplate contains important product information: the model information, communications/technical specifications, and compliance symbols.

4.3.2 Compliance and Safety Symbols

Safety symbol	Description
	Electrical shock! There are residual voltages in the PV inverter. It needs 5 minutes to finish discharge.
	The PV inverter must not be touched when in operation. Its enclosure and heat sinks are extremely hot.
	Electrical shock! This part is charged. Only qualified and/or trained electrical technicians are allowed to perform operations on the inverter.
	If the inverter service life has expired, dispose it in accordance with local rules for disposal of electrical equipment waste. Do not dispose the PV inverter with household garbage.
	The PV inverter is compliant with TUV.

4.4 Installation Requirements

Applies to wall-mounting installation, as described below in detail.

4.4.1 Determining the installation Position

- **Basic Requirements**

- The inverter is protected to IP65 and can be installed indoors or outdoors.
- The installation method and position must be appropriate for the weight and dimensions of the inverter.
- Do not install the inverter in a place where personnel are likely to come into contact with its enclosure and heat sinks because these parts are extremely hot during operation.
- Do not install the inverter in an area that stores flammable or explosive materials.

- **Installation Environment Requirements**

- The ambient temperature must be below 50°C which ensures the inverter's optimal operation and extends its service life.

- b. The inverter must be installed in a well ventilated environment to ensure good heat dissipation.
- c. The inverter must be free from direct exposure to sunlight, rain, and snow to extend its service life. It is recommended that the inverter be installed in a sheltered place. If no shelter is available, build an awning, as shown in Figure 4.3.

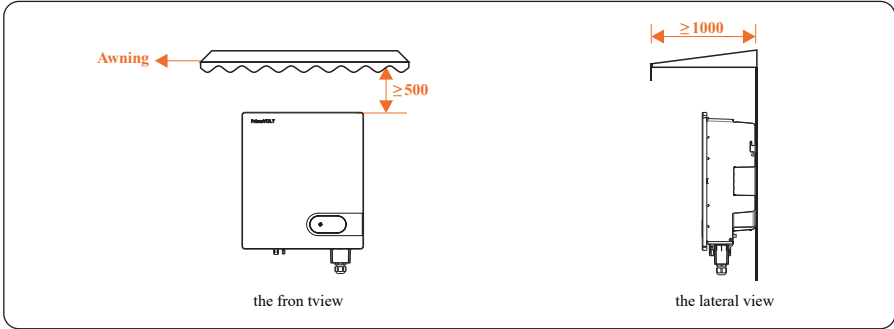

Figure4.3 Installation environment with awning (unit: mm)

- **Carrier Requirements**

- a. The carrier where the inverter is installed must be fire-proof. Do not install the inverter on flammable building materials.
- b. The wall must be solid enough to bear the weight of the inverter.
- c. Do not install the inverter on a wall made of gypsum boards or similar materials with weak sound insulation to avoid noise disturbance in a residential area.

- **Installation Space Requirements**

- a. It is recommended that the inverter is installed at eye level to facilitate operation and maintenance.
- b. Reserve enough clearance around the inverter to ensure sufficient space for installation and heat dissipation, as shown in Figure 4.4.

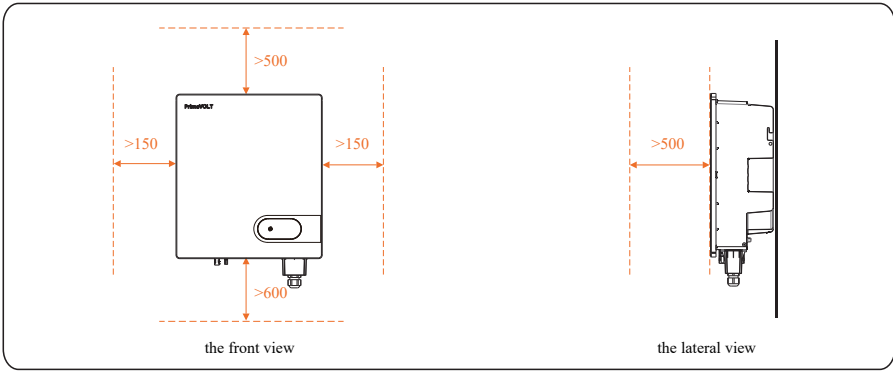

Figure4.4 Installation Space Requirements (unit: mm)

c. When installing multiple inverter, install them along the same line (as shown in Figure 4.5) if sufficient space is available, and install them in triangle mode (as shown in Figure 4.6) or in stacked mode (as shown in Figure 4.7) if no sufficient space is available. The installation modes ensure sufficient space for installation and heat dissipation.

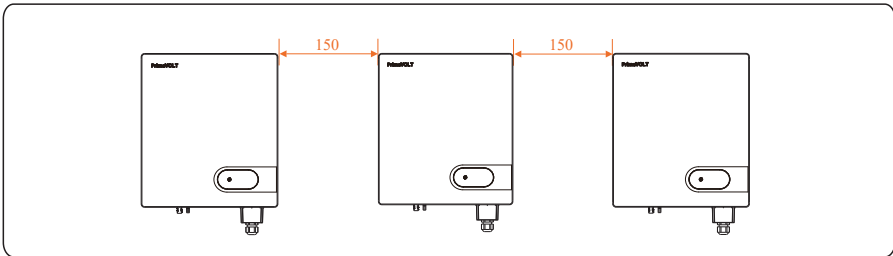

Figure4.5 Installation along the same line (unit: mm)

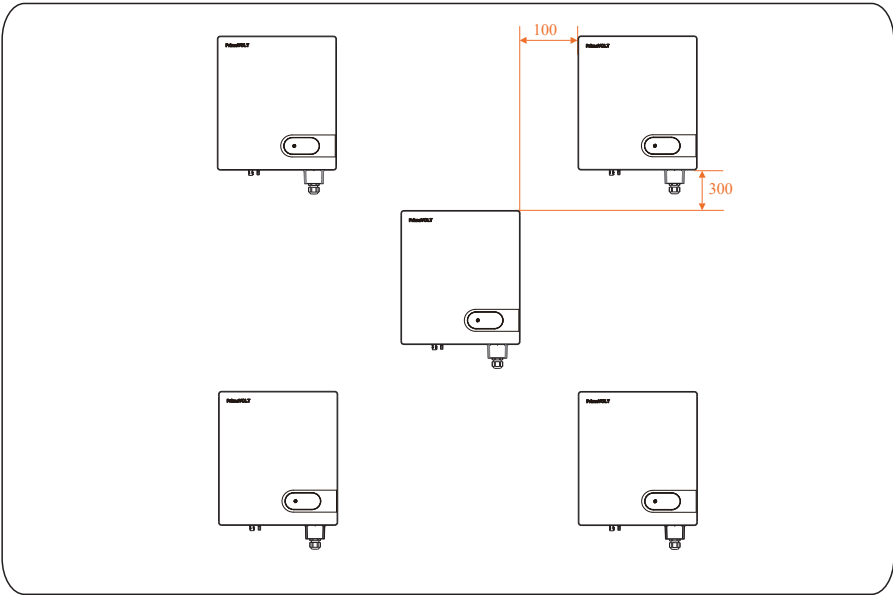

Figure4.6 Installation in triangle mode (unit: mm)

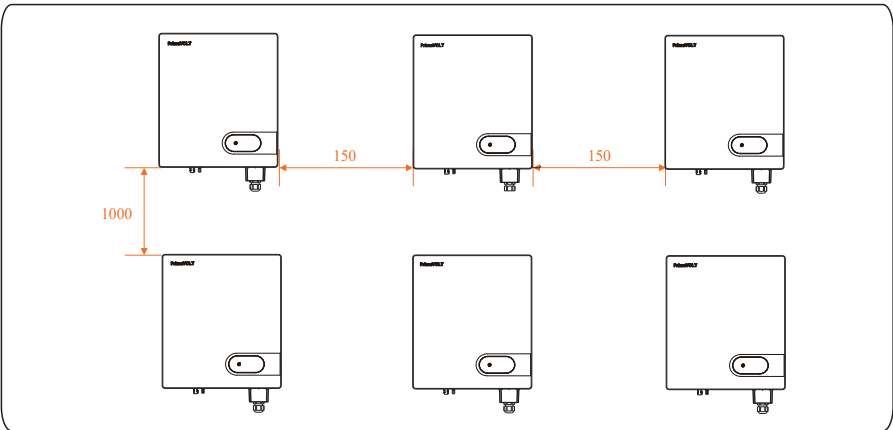

Figure4.7 Installation in stacked mode (unit: mm)



NOTICE

The clearance between multiple inverters must be increased to ensure proper heat dissipation when they are installed in a hot area.

4.4.2 Installation Mode Requirements

Install the inverter upright or at a maximum back tilt of 15 degrees to facilitate heat dissipation. Below are some correct/wrong installation modes, as shown in Figures 4.8 & 4.9.

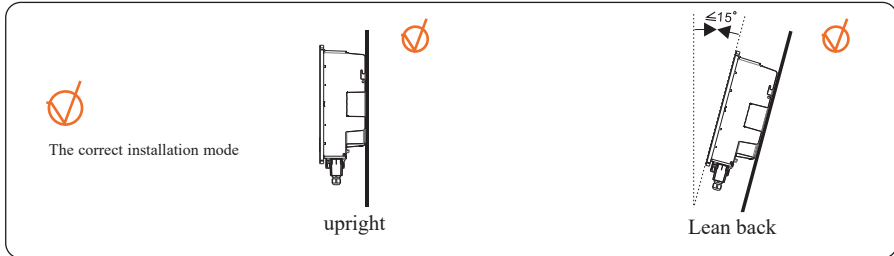

Figures 4.8 The correct installation mode

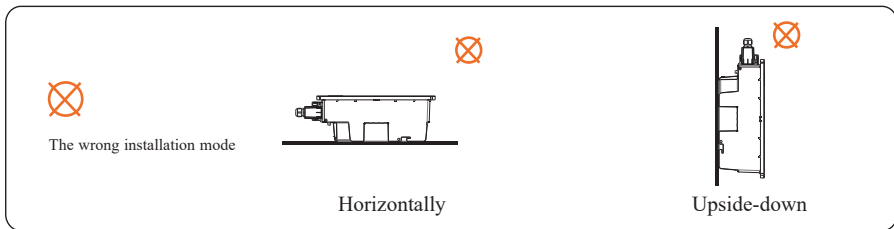

Figure 4.9 The wrong installation modes



NOTICE

The wrong installation will lead to failure of the inverter operation.

4.5 installing a Rear Panel

Before installing the inverter, secure the shipped rear panel to a wall.

Step 1 Move out the rear panel from the packing case.

Step 2 Determine the positions for drilling holes (as shown in Figure 4.10) using the rear panel.

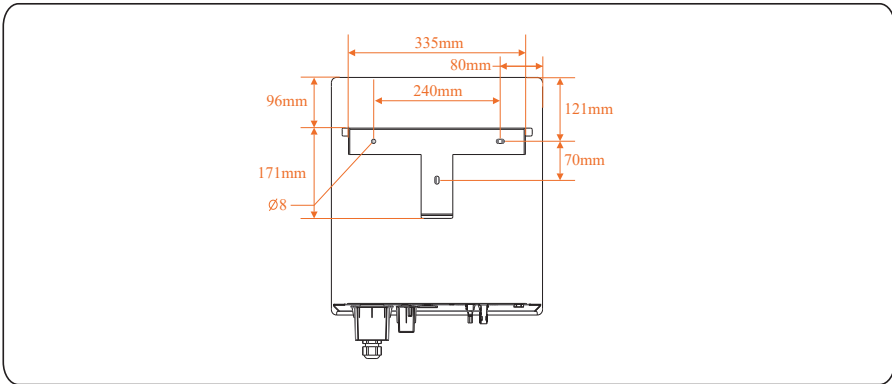

Figure 4.10 Determine the positions for drilling holes (unit : mm)

Step 3 Level the hole positions using a level, and mark the hole positions using a marker (as shown in Figure 4.11).

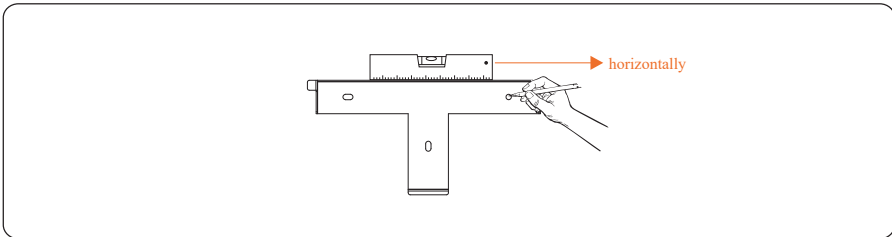

Figure 4.11 mark the hole positions using a marker

Step 4 Drill holes using a hammer drill and install expansion bolts, as shown in Figure 4.12.



DANGER

Before drilling the hole on the wall, ensure no damage on the electric wire and/or water pipe inside the wall.

- a. Drill a hole in a marked position to a depth of 60-65 mm using a hammer drill with a $\Phi 10$ mm bit.
- b. Partially tighten an expansion bolt, vertically insert it into the hole, and knock the expansion bolt completely into the hole using a rubber mallet.

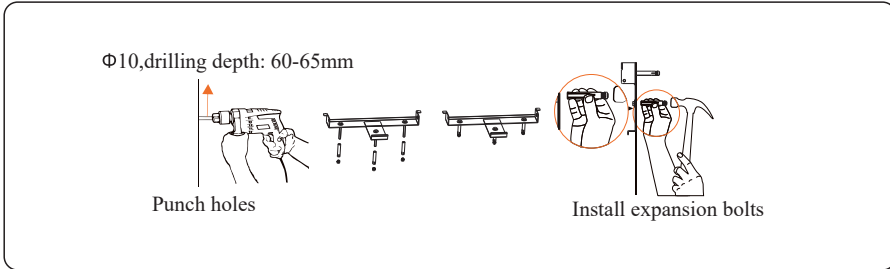

Figure 4.12 Punch holes and install expansion (unit: mm)

- Step 5** Align the rear panel with the holes, insert expansion bolts into the holes through the rear panel, and tighten the expansion bolts to a torque of 3 N·m using a torque wrench, as shown in Figure 4.13.

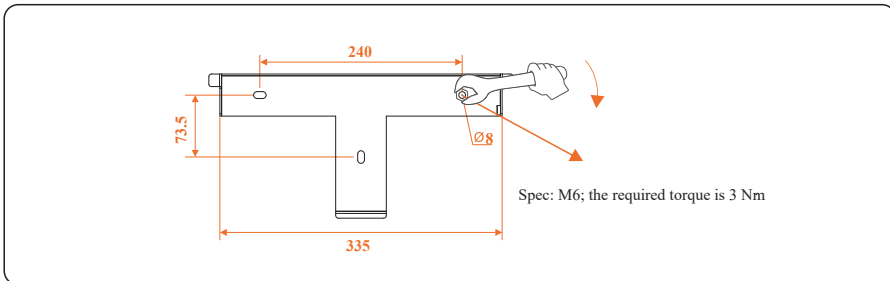

Figure 4.13 Installing the rear panel

4.6 Installing the Inverter

Follow below procedures:

Step 1 The install to hold the handle at both sides of the inverter and then lift and stand the inverter.

Step 2 Mount the inverter on the rear panel and keep them aligned with each other, as shown in Figure 4.14.

Step 3 Tighten the two hexagon screws at the both sides of the inverter to a torque of $3\text{N}\cdot\text{m}$ respectively as shown in Figure 4.14.

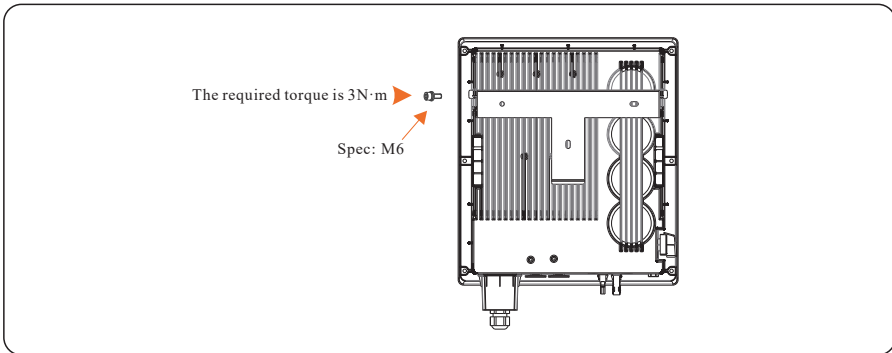



Figure 4.14 Securing the inverter

5 Electrical Connections

 <p>DANGER</p>	<p>Before performing any electrical connections, ensure that both DC and AC Switches are OFF. Otherwise, fatal injury can occur due to the high voltage caused from AC and DC cables.</p>
--	---

5.1 Connecting Protection Ground (PGND) Cables

5.1.1 Preparation

The ground cable and OT terminals have been prepared.

- a. Ground cable: Outdoor copper-core cables with a cross sectional area of 10 mm² or more are recommended.
- b. Specification of screw: M4; the required torque is 1.2N·m.

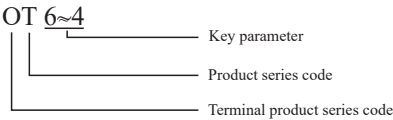

 <p>NOTE</p>	<p>Good grounding for the inverter helps resist the impact of surge voltage and improve the EMI performance. Connect the PGND cable before connecting the AC power cables, DC power cables, and communication cables.</p>
--	---

 <p>NOTE</p>	<p>It is recommended that the ground cable be connected to a nearby ground position. For a system with multiple inverters connected in parallel, connect the ground points of all inverters to ensure equipotential connections.</p>
--	--

5.1.2 Wiring Procedures

Step 1 Remove an appropriate length of the insulation layer from the PGND cable using a wire Stripper; the length is a little bit longer than that of OT terminal’s crimping end by 2mm~3mm, as shown in Figure 5.1.

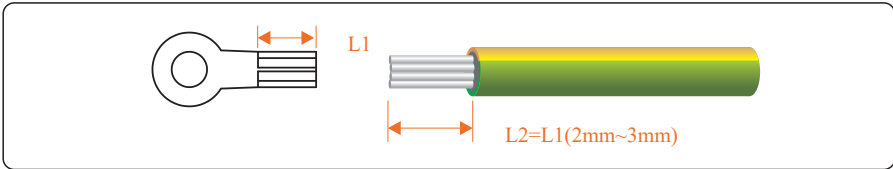

Figure 5.1 Stripped length (unit: mm)

Step 2 Insert the exposed core wires into the crimping areas of the OT terminal and crimp them using hydraulic pliers, as shown in Figure 5.2.

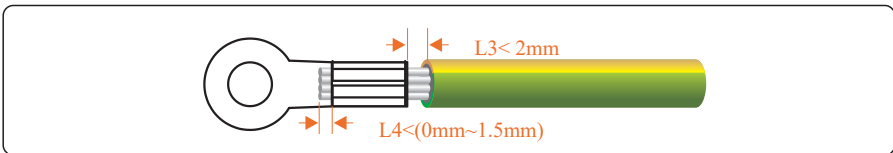

Figure 5.2 Crimping a cable (unit: mm)

Step 3 Remove the ground screws from the ground points, as shown in Figure 5.3.

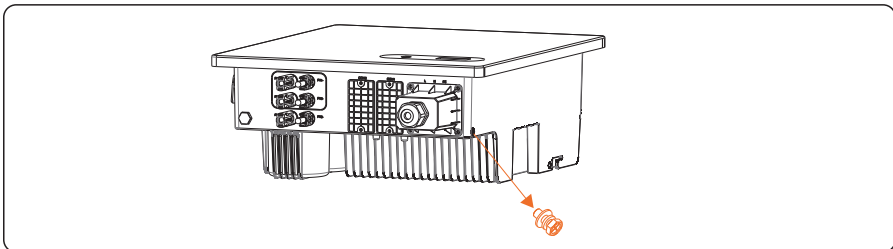

Figure 5.3 Remove the ground screws

Step 4 Secure the PGND cable (done by step1&2) using the ground screw and tighten the screw to a torque of 1.2 N·m using a socket wrench, as shown in Figure 5.4.

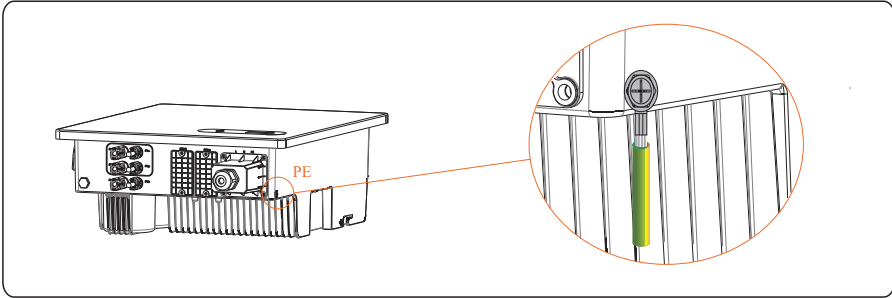

Figure 5.4 Secure the PGND cable

5.2 Connecting AC Output Cables

5.2.1 Preparation

The AC power cable and AC terminals have been prepared.

a. AC power cable: Outdoor copper-core cables are recommended. Table 5.1 describes the specifications.

Cable	Cable type	Cross-sectional Area(mm ²)		Cable Outer Diameter (mm)
		Range	Recommended Value	Range
AC cable	multi-core outdoor cable	8~14	10	14~20



Table 5.1 AC output cable specifications

b. The recommended specifications of circuit breaker are shown in the table below.

Inverter Model	Recommended Value
7K	50A
8K	50A
10K	60A

Table 5.2 Circuit breakers specifications

The RCD used on the main solar supply circuit should be Type A 100mA. This and all associated wiring must be installed in accordance with AS /NZS 4777.1

 <p>WARNING</p>	<p>An independent circuit breaker must be installed on the AC side of each inverter to ensure that the inverter can be safely disconnected from the power grid.</p>
 <p>WARNING</p>	<p>Do not connect loads between the AC output terminals of the inverter and circuit breaker.</p>

5.2.2 Procedure of Connecting AC Cables

 <p>NOTICE</p>	<p>For your operation and safety sake, please prepare multi-stranded wire, crimping terminals and a proper crimping tool before AC Wiring.</p>
---	--

Step 1 Remove an appropriate length of the jacket and insulation layer from the AC output cable.

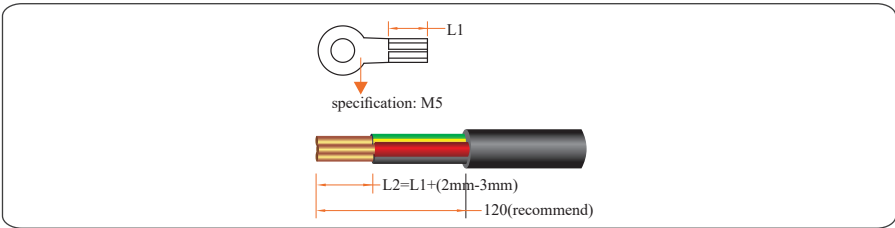

Figure 5.5 Stripped length (unit: mm)

Step 2 Insert the exposed core wires into the crimp area of the OT terminal and crimp them using hydraulic pliers. Wrap the wire crimp area with heat shrink tubing or PVC insulation tape.

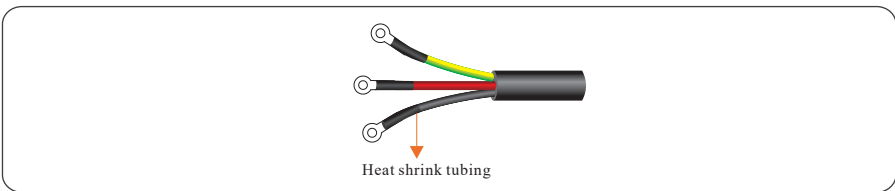

Figure 5.6 Crimping OT terminals

Step 3 Insert the processed AC output cables through waterproof terminals with reserved wire length for electrical connecting.

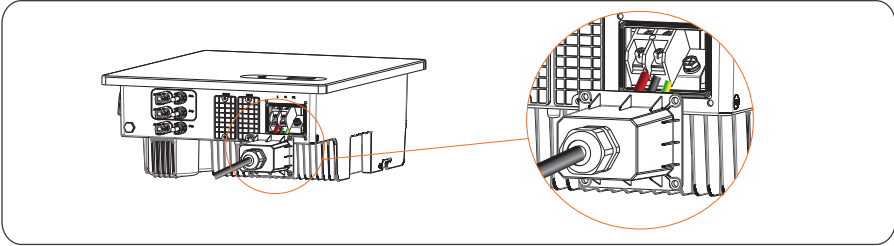

Figure 5.7 Connecting AC cable

Step 4 Rout AC output cables to L, N and PE on the AC terminal block respectively, and tighten them using screw driver to a torque of $1.5\text{N}\cdot\text{m}$.

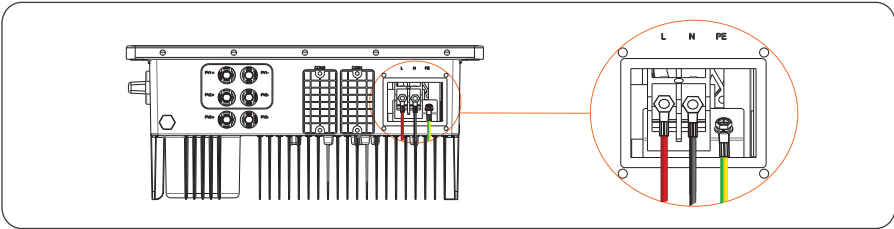

Figure 5.8 Connecting AC cable

Step 5 Aligning with the hole position on the AC terminal cover, use a screw driver to tighten screws to a torque of $1.2\text{N}\cdot\text{m}$.

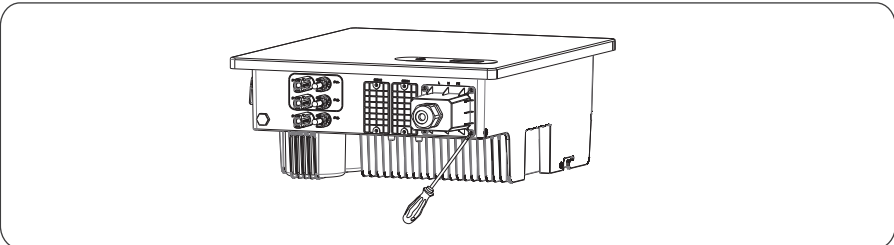



Figure 5.9 Connecting AC Connector

Step 6 Use a torque wrench to tighten the locking cap on the AC cable to a torque of $5\text{N}\cdot\text{m}$.

5.3 Connecting the PV Strings

 DANGER	PV Strings connection needs below prerequisites; otherwise, an electrical shock can occur.
PV modules generate electric energy when exposed to sunlight and can create an electrical shock hazard. Therefore, when connecting the PV modules, shield them with opaque cloth.	
Before connecting DC input power cables, ensure that the voltage on the DC side is within the safe range and that the DC SWITCH on the inverter is OFF. Otherwise, high voltage may result in electric shock.	
When the inverter is grid-tied, it is not allowed to maintain DC input power cables, such as connect or disconnect a string or a module in a string. Only after the inverter enters in shutdown mode, it is allowable for preceding DC input power cables maintenance.	

 WARNING	Grounding the PV Strings needs below prerequisites; otherwise, a fire can occur.
PV modules connected in series in each PV string must be of the same specifications.	
The maximum open-circuit voltage of each PV string must be always lower than or equal to its permitted range.	
The maximum short circuit current of each PV string must be always lower than or equal to its permitted range.	
The positive and negative terminals of PV modules must be connected to the positive and negative DC input terminals of the inverter respectively.	
During the installation of PV strings and the inverter, the positive or negative terminals of PV strings cannot be connected with short circuit.	

5.3.1 Preparation

Route collecting for the installation of PV strings and inverter.

Input Route	Number of Input Route
1	Connected to any route
2	Connected to route 1 & 3
3	Connected to route 1, 2 & 3

PV Strings DC input cable and connectors have been prepared; Table 5.2 lists the recommended outdoor copper-core DC input cable specifications.

Cable	Cable type	Cross-sectional Area(mm ²)		Cable Outer Diameter (mm)
		Range	Recommended Value	Range
DC cable	common PV cables in the industry (model: PV1-F)	4~6	4	5~8

Table 5.2 Recommended DC input cable recommended specifications

- Connectors of PV Strings: Positive and negative DC input connectors are used, as shown in Figure 5.8 and Figure 5.9.

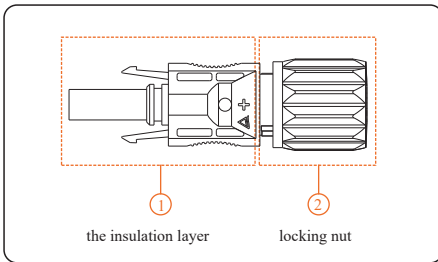

Figure 5.10 Positive connector compositions

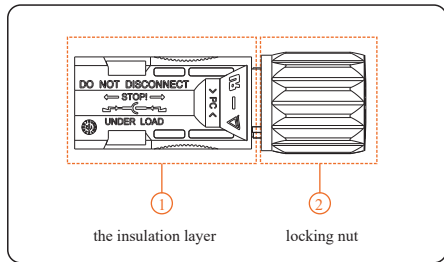



Figure 5.11 Negative connector compositions

 <p>NOTE</p>	<p>Positive and negative metal connectors are packed with positive and negative connectors respectively when shipped out. After unpacking, keep the positive and negative ones separate to avoid confusion.</p>
---	---

- Procedures of connecting the PV Strings

Step 1 Remove an appropriate length of the insulation layer from the positive and negative power cables using a wire stripper, as shown in below Figure.

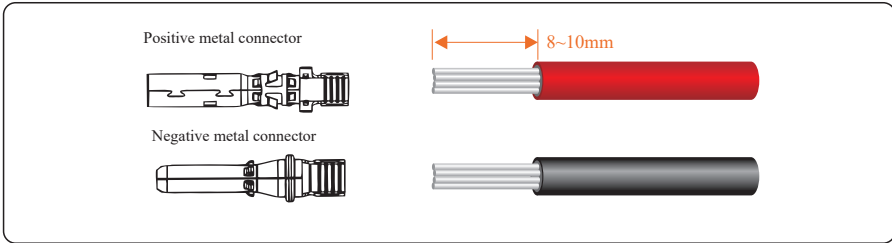

Figure 5.12 Removing insulation layer for DC cable (unit: mm)

Step 2 Insert the exposed areas of the positive and negative power cables into the metal terminals of the positive and negative connectors respectively and crimp them using a crimping tool, as shown in Figure 5.13.

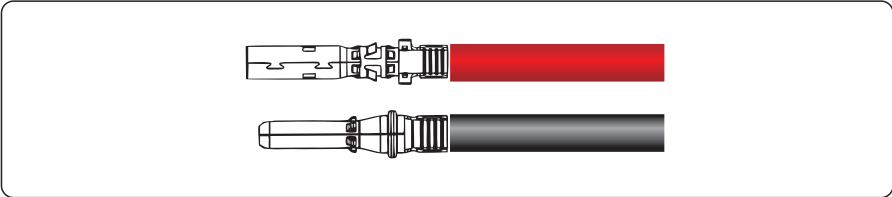

Figure 5.13 Crimping a metal connector

Step 3 Insert the crimped positive and negative power cables into the corresponding positive and negative connectors until a "click" sound is heard, as shown in Figure 5.14.

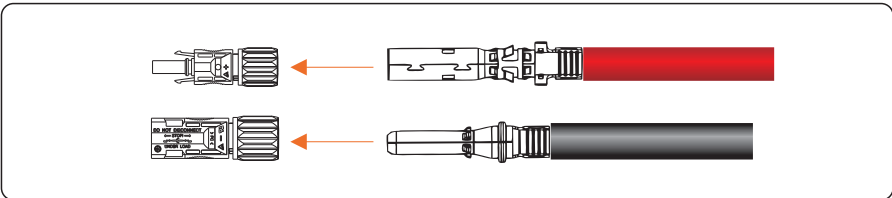

Figure 5.14 Connecting positive and negative connectors

Step 4 Tighten the locking nuts on the positive and negative connectors using a removal wrench, as shown in Figure 5.15.

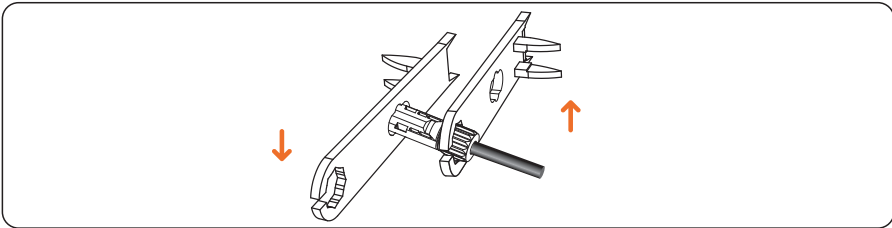

Figure 5.15 Locking connectors

Step 5 Measure the voltage of every route Strings using a multimeter. Ensure that the polarities of the DC input power cables are correct, as shown in Figure 5.16.

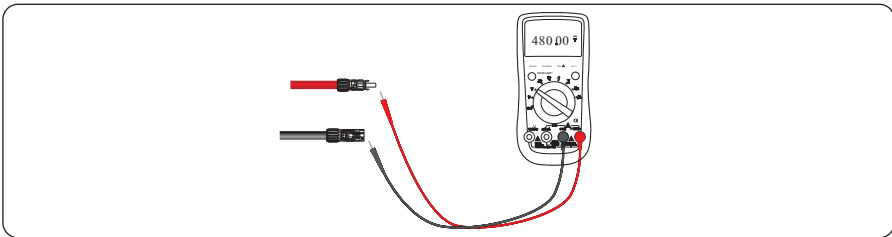

Figure 5.16 Checking the voltage of every route Strings

Step 6 Insert the positive and negative connectors into their corresponding terminals of the inverter until a "click" sound is heard, as shown in Figure 5.17.

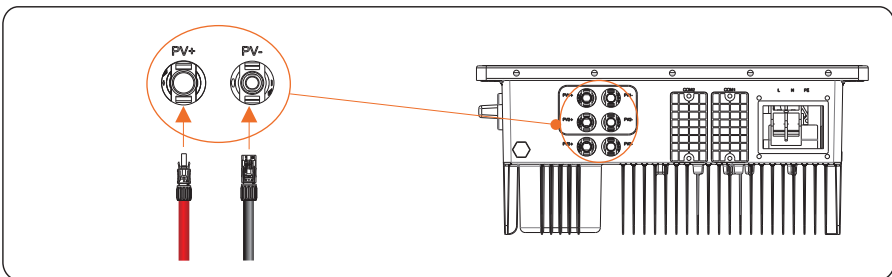

Figure 5.17 Connecting to the inverter

Step 7 After connecting the PV strings,,ensure that all connectors are in position by checking for resistance when a slight pull is applied.

5.4 Connecting Communication Cables

5.4.1 Communication Mode Description

You can use the following communication modes to implement communication: Bluetooth, WIFI, GPRS and RS485 all of which are described as follows.

- **Bluetooth Module**

You can turn on the Bluetooth function of the mobile phone, and set parameters and monitor data of the inverter through the mobile APP. For details about operation, refer to APP User Manual.

- **WIFI & GPRS & RS485 Modules**

Following figure show inverter's interface to connect WIFI, GPRS and RS485 accessory, please refer user manual of accessory for connecting method and its setting.

Module	Functiondescription
WIFI	WIFI module implements communication with Cloud server through wireless network to monitor PV inverter's data status. For more details, refer to WIFI Product Application Manual.
GPRS	GPRS module communicates with Cloud server through a mobile phone to monitor PV inverter's data status. For more details, refer to GPRS Product Application Manual.
RS485	RS485 switching module monitors PV inverter's data status through collecting and uploading data to Cloud server. For more details, refer to RS485 switching Product Application Manual.
NOTE	You can choose and buy WIFI/GPRS/RS485 communication modules from the company. The baud rate supported by RS485: 9600BPS

Table 5.4 WIFI & GPRS & RS485 Modules Description

- **Download APP**
- Scan the QR code on the inverter to download the APP.
- Download APP from the App Store or Google Play.

The APP should access some permissions such as device's location. You need to grant all access rights in all pop-up windows when installing the APP or setting your phone.

5.5 Power limit (optional)

5.5.1 Wiring diagram of Inverter+CT

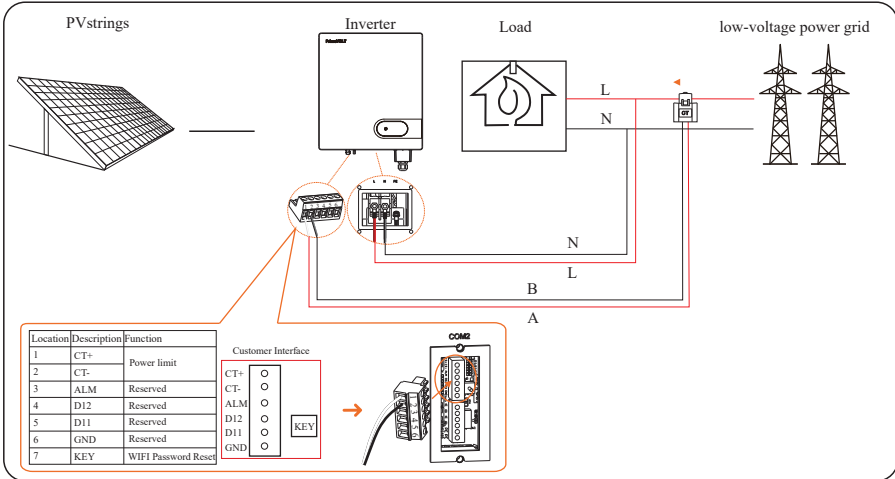

Figure5.18 Wiring diagram of Inverter+CT

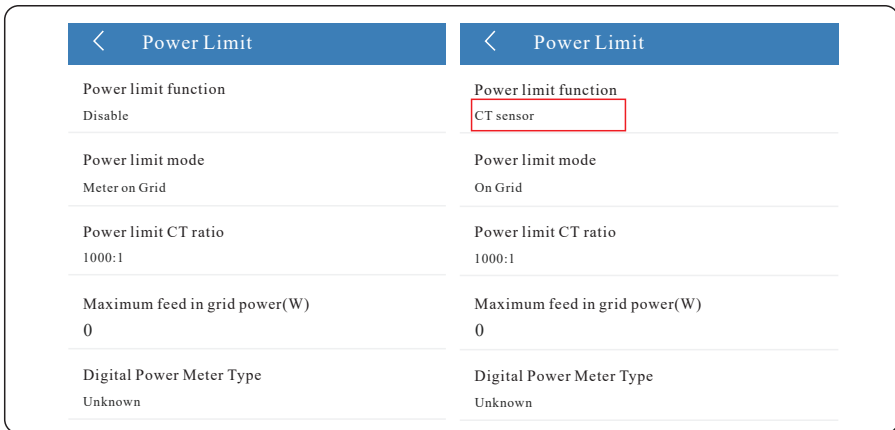

Figure 5 19 Settings via APP

- Power limit function set to “ CT sensor ”
- Set the CT position base on the meter installed on load or on grid
- Set maximum feed-in grid power if needed
- Set Power limit CT ratio

5.5.2 Wiring diagram of Inverter+Meter

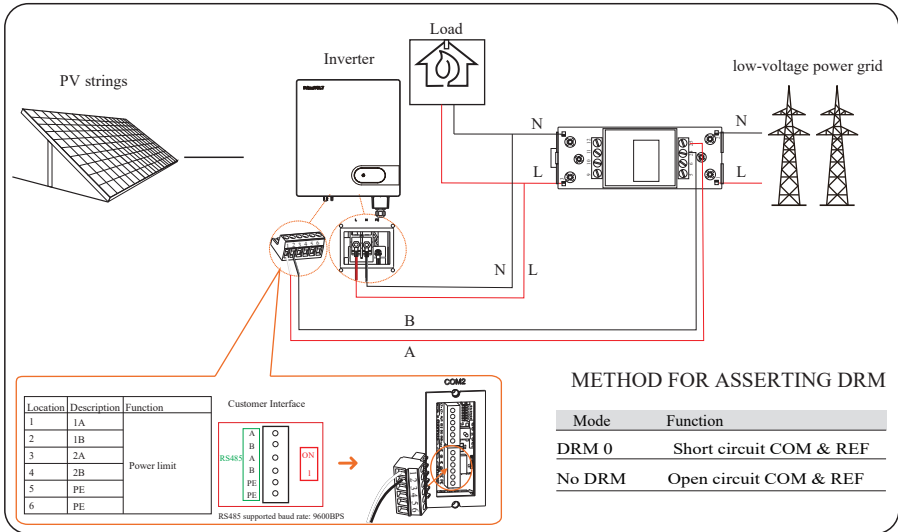

Figure5.20 Wiring diagram of Inverter+Meter

Power Limit	Power Limit
Power limit function Disable	Power limit function Digital Power Meter
Power limit mode Meter on Grid	Power limit mode On Grid
Power limit CT ratio 1000:1	Power limit CT ratio 1000:1
Maximum feed in grid power(W) 0	Maximum feed in grid power(W) 0
Digital Power Meter Type Unknown	Digital Power Meter Type DDSU666

Figure5.21 Settings via APP

- Set the “Power limit function ” to“ Digital Power Meter ”
- Set the Digital Power Meter Type
- Set the meter position base on the meter installed on load or on grid
- Set maximum feed-in grid power if needed
- Set “ Power limit CT ratio” only when using inverter+CT

When “ Power limit function ” is set to “ Digital Power Meter ”, the RS485 of inverter will change to a Host that will communicate with digital meter using Modbus-RTU protocol (9600 BPS, 8 data bit, 1 stop bit, no parity data format) through communication address 1. Please make sure that the meter is set to Modbus-RTU, 9600, 8-N-1 with address 1. For details of digital meter setting operation, please refer to the meter user manual.

5.5.3 Country code configuration (only for Administrator)

Go to [Console > Grid Parameters](#) page. Follow the steps below to configure the country code for Australia only for Administrator status.

The screenshot illustrates the configuration process in three stages:

- Initial State:** The sidebar menu on the left shows 'Grid Parameters' selected. An arrow points from this menu item to the 'Login As Administrator' dialog box.
- Login Step:** The 'Login As Administrator' dialog prompts the user to 'Enter administrator password'. A text box for the password and 'Cancel'/'OK' buttons are visible. An arrow points from the 'OK' button to the next screen.
- Configuration Step:** The 'Grid Parameters' page is shown with the 'Standard Code' field set to 'Unknown'. An arrow points from this field to the 'Standard Code' selection dialog.
- Selection Step:** The 'Standard Code' dialog lists options: 'AU (AS/NZS4777.2:2020 Australia B)', 'AU (AS/NZS4777.2:2020 Australia A)', 'AU (AS/NZS4777.2:2020 Australia C)', and 'NZ (AS/NZS4777.2:2020 New Zealand)'. A 'Cancel' button is at the bottom.

Note: You need to enter the login password only for the first time.

Note:

For Australian Market: Region settings must be selected during commissioning. To comply with AS/NZS 4777.2:2020, please select from Region A/B/C. Please contact your local electricity grid operator on which region to select.

• **Note on Regional Safety Settings**

Regional Safety Setting is a mandatory selection when configuring the system—the system will not operate if it is not selected.

You may be prompted to update the inverter software. Do this if requested.

For convenience the Regional Safety Settings are set by selecting the Region from the list provided in the app. The list is maintained with the latest settings required by AS4777.2:2020. Selection of a region automatically selects Power Quality Response Mode settings, including:

- Voltage balance mode (where available)
- Voltage and frequency limits
- Sustained operation for frequency variations
- Grid Protection
- Power Rate Limits
- Frequency Response Limits
- Voltage Disturbance Withstand
- Volt-Var response
- Volt-Watt response
- Fixed Power Factor Mode
- Reactive Power mode

Note

The local grid operator may request a non-standard safety setting for an installation. If no, contact our company for assistance in changing settings.

• **Maintenance**

Go to [Console](#) page. And click [Maintenance](#)

Then you need to enter password in a popup window (as shown below).

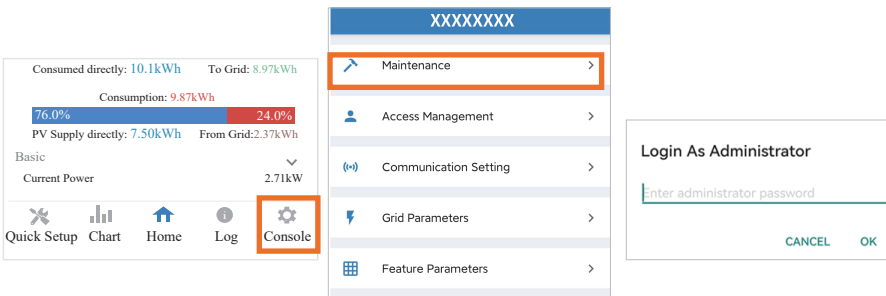

In this page, you can view the basic information like DSP version information, do some maintaining operations like turn off/on the inverter and manage data.

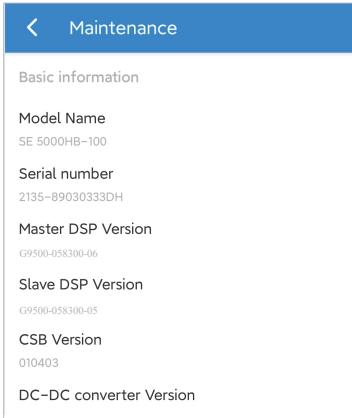

5.6 Installation Verification

Check the following items after the inverter is installed according to Table 5.4.

1. No other objects put on the PV inverter.
2. All screws ,especially the screws used for electrical connections, are tightened.
3. The PV inverter is installed correctly and securely.
4. Ground, AC, DC and Communications cables are connected tightly/correctly and securely.
5. Check there is no open circuit or short-circuits at AC and DC terminals using multimeter.
6. Waterproof connectors at AC terminals and RS485 ports are plugged with waterproof plugs tightly.
7. Covers at AC terminals are tightened.
8. Idle terminals are sealed.
9. All safety warning symbols are intact and complete on the inverter.

Table5.4 Self-check items after installation

6 System Operation

6.1 Powering ON the Inverter

Step 1: Switch ON the AC circuit breaker

Step 2: If the inverter has a switch, turn the switch to "ON" state.

Step 3: Observe statuses of LED indicator lights on the inverter according to Table 7.1.



NOTE

When LED status lights display the inverter has entered grid-connecting, it means the inverter is operating well. Any query during operating the PV inverter, call your dealer.

6.2 Powering OFF the Inverter

Step 1: Run a shutdown command on the mobile APP.

Step 2: Switch off the circuit breaker at AC terminal.

Step 3: If the inverter has a switch, turn the switch to "OFF" to observe.



WARNING

After the inverter powers off, the remaining electricity and heat may still cause electrical shock and body burns. Please only begin servicing the inverter ten minutes after the power-off.

7 User Interface

Display screen of inverter is composed of LED indicator and (LCD is optional for some models of inverter). LED contains three color states, blue, green and red respectively. For more details, refer to Table 7.1 HMI specification definition.

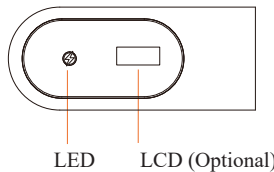

NOTE

You can view & set data of the inverter through inverter APP. For details about operation, refer to APP User Manual. APP User Manual is available for free from website.

7.1 HMI specification definition

LED Indicator	Description	Status
Blue led	Standby	blink (slowly)
	Normal status	on
Green led	Limited power operation	on
Red led	Refer to the table below	
Warning Definition	LCD Display	Status
Grid over voltage	A0 Grid OV	Red led blink (slowly)
Grid under voltage	A1 Grid UV	Red led blink (slowly)
Grid absent	A2 Grid Loss	Red led blink (slowly)
Grid over frequency	A3 Grid OF	Red led blink (slowly)
Grid under frequency	A4 Grid UF	Red led blink (slowly)
PV over voltage	B0 PV OV	Red led blink (quickly)
Insulation resistance abnormal (Earth Fault)	B1 Imp abn	Red led blink (quickly)
Leakage current abnormal (Earth Fault)	B2 Lkge abn	Red led blink (quickly)
Control power abnormal	C0 Power fail	Red led on
Arc fault	C1 Arc fault	Red led on
Dc bias current abnormal	C2 OP Dc OC	Red led on
Inverter relay abnormal	C3 RLY abn	Red led on
Inverter over temperature	C5 SYS OT	Red led on
Leakage current HCT abnormal	C6 Lkg CT abn	Red led on
System fault	C7 SYS err	Red led on
Fan fault	C8 FAN lock	
DC link under voltage	C9 Bus UV	Red led on
DC link over voltage	CA Bus OV	Red led on
Internal Communications Fault	CB COM err	Red led on
Software version incompatibility	CC FW Incomp	Red led on
EEPROM fault	CD EEP err	Red led on
Sampling inconsistency	CE Inconsis	Red led on
Boost circuit abnormal	CG Bst abn	Red led on
Remote off	CN RMT OFF	

Table 7-1 HMI specification definition

If the Inverter is malfunctioning, a small horn symbol will appear in the APP interface. You can get specific fault information by clicking on the small horn symbol as below images.

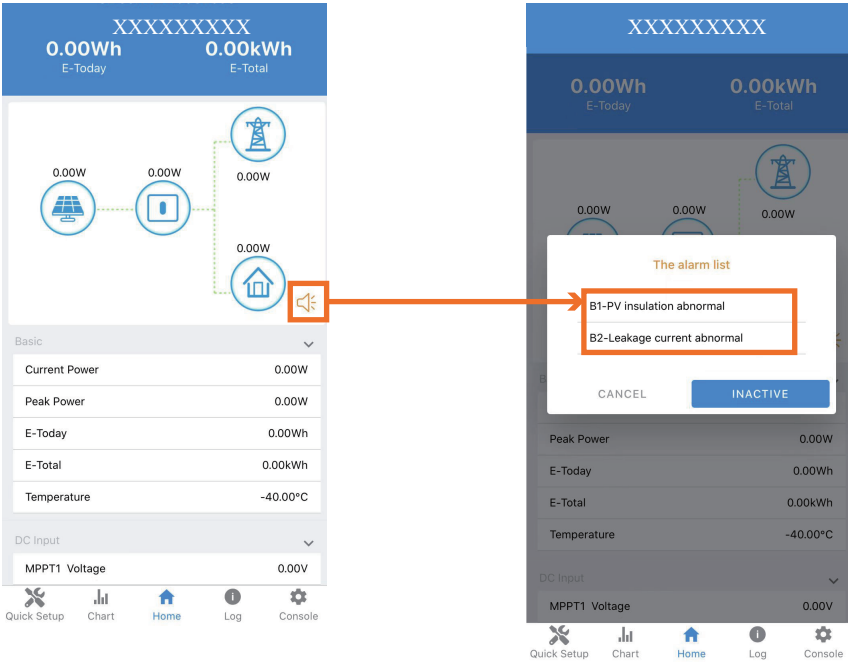

7.2 LCD automatic-page-turning display

Mode	Display content	Note
The LCD display interface of the inverter standby state is shown in the following sequence:	SE 5kTL Ver 01.00.00	Model name Version
	Udc 360/360V Uac 220V	PV voltage AC voltage
	Today 80kWh Etot 8000kWh	Today Energy Total Energy
	A0 Grid OV B1 Imp abn	Warning
The interface of LCD display for countdown of inverter gridconnected is shown in the right picture:	Starting 60s	Start counter down
The LCD display interface of the inverter grid-connected state is shown in the figure on the right:	Pac 5000W Today 50kWh	Output power Today Energy
	Etot 8000kWh Htot 80000hr	Total Energy Total Hours
	Udc 360/360V Idc 8/8A	PV voltage PV current
	Uac 220V Iac 28A	AC voltage AC current
	08:00 2018-08-08	hour: minute year/month/day

Table7.2 LCD automatic-page-turning display

8 Maintenance



WARNING

Before maintaining and commissioning inverter and its peripheral distribution unit, switch off all the charged terminals of the inverter and wait at least 10 minutes after the inverter is powered off.

8.1 Routine Maintenance

Check Item	Check Content	Maintain content	Maintenance Interval
inverter output status	Statistically maintain the status of electrical yield, and remotely monitor its abnormal status.	NA Weekly	
PV inverter cleaning	Check periodically that the heat sink is free from dust and blockage.	Clean periodically the heat sink.	Yearly
PV inverter running status	Check that the inverter is not damaged or deformed. Check for normal sound emitted during inverter operation. Check and ensure that all inverter communications is running well.	If there is any abnormal phenomenon, replace the relevant parts.	Monthly
PV inverter Electrical Connections	Check that AC, DC, and communication cables are securely connected; Check that PGND cables are securely connected; Check that cables are intact and there are not wire aging;	If there is any abnormal phenomenon, replace the cable or re-connect it.	Semiannually

Table 8.1 Maintenance checklist and interval

8.2 Inverter Troubleshooting

When the inverter has an exception, its basic common warning and exception handling methods are shown in the table 8.2.

Alarm Name	Causes	Measures Recommended
Grid Over Voltage	The grid voltage exceed sits allowable range.	<ol style="list-style-type: none"> 1. If the alarm occurs accidentally, possibly the power grid is abnormal accidentally. No extra action is needed. 2. If the alarm occurs repeatedly, contact the local power station. After receiving approval of the local power bureau, revise the electrical protection parameters setting on the inverter through mobile APP. 3. If the alarm persists for a long time, check whether the AC circuit breaker/AC terminals is disconnected or not ,or if the grid has a power outage.
Grid Under Voltage		
Over Frequency		
Under Frequency		
PV Over Voltage	PV modules input voltage exceeds the inverter's allowable range.	Check the number of PV modules and adjust it if need.
PV Under Voltage	PV modules input voltage is under the inverter's defaulted protection value.	<ol style="list-style-type: none"> 1. When sunlight intensity weakens, PV modules voltage decreases. No action is needed. 2. If such phenomena occur when sunlight intensity does not weaken, check if there is short circuit, open circuit etc. in the PV strings.
Insulation Resistance Abnormal (Earth Fault)	A short circuit exists between PV strings and protection ground. PV strings are installed in a long-term moist environment.	<ol style="list-style-type: none"> 1. Check the insulation resistance against the ground for the PV strings. If a short circuit has occurred, rectify the fault. 2. If the insulation resistance against the ground is less than the default value in a rainy environment, set Insulation resistance protection on APP.

Residual Current Abnormal (Earth Fault)	The insulation resistance against the ground at the input side decreases during the inverter operation, which causes excessively high residual current.	<ol style="list-style-type: none"> 1. If the alarm occurs accidentally, possibly the external circuits are abnormal accidentally. The inverter automatically recovers to the normal operating status after the fault is rectified. 2. If the alarm occurs repeatedly or lasts a long time, check whether the insulation resistance against the ground of PC strings is too low.
PVStrings Abnormal	PV strings have been shielded for a long time. PV strings are deteriorating.	<ol style="list-style-type: none"> 1. Check whether the PV string is shielded. 2. If the PV string is clean and not shielded, check whether the PV modules are aging or deteriorated.
PV Strings Reverse	The cables of PV strings are connected reversely during the inverter installation.	Check whether the cables of PV strings are correctly connected. If they are connected reversely reconnect the cables.
BUS Under Voltage	Abnormal internal energy control imbalance has been triggered by the PV Strings/grid sharp change of working conditions.	<ol style="list-style-type: none"> 1. If the alarm occurs occasionally the inverter can automatically recover to the normal operating status after the fault is rectified. 2. If the alarm occurs repeatedly contact your dealer for technical support.
BUS Over Voltage		
Invert Module Fault		
BOOST Fault		
EEPROMFault	EEPROM Component damaged.	Replace the monitoring board.
Zero power generation and Yellow alarm light illuminating in remote monitor system	Communicat	If modem or other data logger is used, please reboot it; if still does not work after rebooting, contact your dealer.

Remote monitor displays zero power generation	Communications outage	If modem or other data logger is used, please reboot it; if still does not work after rebooting contact your dealer.
Remote monitor displays no output voltage	Output switch tripping	Check if DC switch is damaged, and if not, switch it to ON. If it still doesn't work contact your dealer.
Inverter of fgrid	1. Power grid fault; 2. DC switch tripping	1. Wait till power is restored. 2. Turn DC switch to ON, and if DC switch trips a lot, contact your dealer.

Table 8.2 Common troubleshooting measures

 NOTE	If you cannot clear the preceding alarm according the measures recommended, contact your dealer timely.
---	---

8.3 Removing the Inverter

Perform the following procedures to remove the inverter:

Step 1: Disconnect all cables from the inverter including communications cables DC input power cables, AC output power cables, and PGND cables.

Notes:

When removing DC input connector insert the removal wrench to the bayonet press the wrench down and take out the connector carefully.

Step 2: Remove the inverter from the rear panel.

Step 3: Remove the rear panel.

 WARNING	Before removing DC input connector, double check DC input switch is turned to OFF to avoid inverter damage and personal injury.
--	---

9 Disposal of the Inverter

The PV inverter and its packing case are made from environment-friendly materials. If the inverter service life has expired, do NOT discard it with household garbage; dispose the inverter in accordance with local environmental laws and regulations.

10 Technical Specifications

Model	7K	8K	10K
Efficiency			
Max. Efficiency	98.2%	98.2%	98.2%
European Efficiency	97.4%	97.5%	97.6%
Input(PV)			
Max. PV configuration (STC ¹)	133%		
Max. Input Voltage	550V		
Rated Input Voltage	360V		
Max. Input Current	40A (2*20A)	50A (2*15A+20A)	
Max. Short Circuit Current	52A (2*26A)	66A (2*20A+26A)	
Start Input Voltage	90V		
MPPT Operating Voltage Range	60V-540V		
Max. Number of PV Strings	2 (1/1)	3 (2/1)	
No. of MPPTs	2		
Output(Grid)			
Rated AC Active Power	7,000W	8,000W	10,000W
Max. AC Apparent Power	7,700VA	8,800VA	10,000VA
Max. AC Active Power(PF=1)	7,700W	8,800W	10,000W
Max. AC Output Current	35A	40A	45.5A
Rated AC Voltage	220V/230V, L+N+PE		
AC Voltage Range*	160V-300V (Adjustable)		
Rated Grid Frequency	50Hz/60Hz		
Grid Frequency Range**	45Hz-55Hz / 55Hz-65Hz (Adjustable)		
THDI	<3% Rated Power		
DC Current Injection	<0.5%I _n		
Power Factor	> 0.99 Rated power (Adjustable 0.8 Leading - 0.8Lagging)		
Inrush Current	90A		
Protection			
DC Switch	Support		
Anti-islanding protection	Support		
AC overcurrent protection	Support		
AC short circuit protection	Support		
DC reverse connection	Support		
Surge Arrester	DC Type III (Optional) / AC Type III		
Insulation detection	Support		

1 STC : Standard Test Conditions.

General	
Topology	Transformerless
IP Rating	IP65
Night Self Consumption	<1W
Cooling	Natural cooling
Operating Temperature Range	-25%-60%
Relative Humidity Range	0-100%
Max. Operating Altitude	4000m
Noise	<30dB
Dimensions (W*H*D)	400mm*450mm*170mm
Weight	16kg
HMI & COM	
Display	Wireless & APP +LED, LCD(Optional)
Communication	WiFi (Optional) / GPRS (Optional) / RS485 (Optional)
Certification	
Safety	IEC62109-1, IEC62109-2
Grid Code	IEC61727 / 62116, ABNT 16149 / 16150, IEEE 1547, AS 4777
Warranty	10 Years

Notes:

- 1) Grid power voltage range can be set according to national voltage standards;
- 2) Power grid frequency range can be set according to national grid standards;
- 3) The preceding technical specifications are subject to change without prior notice. The listed specifications are for your reference only.