

PrimeVOLT

USER MANUAL

Three Phase Grid-tied PV String Inverter

Natural cooling series

PV 5KTL-D3/G2

PV 6KTL-D3/G2

PV 8KTL-D3/G2

PV 10KTL-D3/G2

PV 12KTL-D3/G2

PV 15KTL-D3/G2

Fan cooling series

PV 10KTL-D3/G2P

PV 15KTL-D3/G2P

PV 17KTL-D3/G2

PV 20KTL-D3/G2

Fan cooling series

PV 22KTL-D3/G2

PV 25KTL-D3/G2

Applicable model: 5K/6K/8K/10K/12K/15K/17K/20K/22K/25K



History

VERSION	ISSUED	COMMENTS
1.0	16-Dec-22	First release

Preface

About This Manual

This manual describes the installation, electrical connection, commissioning and maintenance, APP operation of the inverter. Please first read the manual and related documents carefully before using the product and store it in a place where installation, operation and maintenance personnel can access it at any time. The illustration in this user manual is for reference only. This user manual is subject to change without prior notice.

Tagert Group

Inverters must be installed by professional electrical engineers who have obtained relevant qualifications.

Scope

Natural cooling series

PV 5KTL-D3/G2

PV 6KTL-D3/G2

PV 8KTL-D3/G2

PV 10KTL-D3/G2

PV 12KTL-D3/G2

PV 15KTL-D3/G2

Fan cooling series

PV 10KTL-D3/G2P

PV 15KTL-D3/G2P

PV 17KTL-D3/G2

PV 20KTL-D3/G2





Fan cooling series

PV 22KTL-D3/G2

PV 25KTL-D3/G2

Conventions

The following safety instructions and general information are used within this user manual.

 DANGER	Indicates an imminently hazardous situation which, if not correctly followed, will result in serious injury or death.
 WARNING	Indicates a potentially hazardous situation which, if not correctly followed, will result in serious injury or death.
 CAUTION	Indicates a potentially hazardous situation which, if not correctly followed, could result in moderate or minor injury
 NOTICE	Indicates a potentially hazardous situation which, if not correctly followed, could result in equipment failure to run, or property damage.
 NOTE	Call attention to important information, best practices and tips: supplement additional safety instructions for your better use of the ESS inverter to reduce the waste of you resource

CONTENTS

Preface

- About This Manual
- Target Group
- Scope
- Conventions

1. Safety

- 1.1 Symbols Used
- 1.2 Safety Instruction

2. Product Introduction

- 2.1 Product Overview
- 2.2 Model Definition
- 2.3 Product Appearance

3. Unpack and Storage

- 3.1 Unpack and Check
- 3.2 Storage Inverter
- 3.3 Identify Inverter

4. Installation

- 4.1 Selecting the Mounting Location
- 4.2 Mounting

5. Electrical Connection

- 5.1 Grounding
- 5.2 AC Connection
- 5.3 DC Connection
- 5.4 Communication Connection
- 5.5 Power limit

6. Startup/Shutdown Procedure

- 6.1 Check before startup/shutdown Procedure
- 6.2 Startup Procedure
- 6.3 Shutdown Procedure

7. User Interface

8. Troubleshooting and Maintenance

- 8.1 Inverter Troubleshooting
- 8.2 Maintenance

9. Technical Specifications

1 Safety









Before using the inverter, please read all instructions and cautionary markings on the unit and manual. Put the instructions where you can take them easily.

The inverter of us strictly conforms to related safety rules in design and test. Local safety regulations shall be followed during installation, operation and maintenance. Incorrect operation work may cause injury or death and damage to the inverter and other operator or a third party.

To avoid injury and damage to the inverter and other operator, please follow the safety precautions.

1.1 Symbols Used

The sign of caution stick on inverter.

Safety Symbol	Description
	Danger of high voltage! Only qualified personnel may perform work on the inverter.
	Danger of high voltage. Residual voltage in the inverter need 5 mins to discharge, wait 5 mins before operation.
	Danger of hot surface
	Fire danger
	Environmental Protection Use Period
	Refer to the operating instructions
	If the inverter service life has expired, dispose it in accordance with local rules for disposal of electrical equipment waste. Do not dispose the PV inverter with household garbage.
	Grounding terminal

1.2 Safety Instruction

- Installation and maintenance of inverters must be performed by qualified personnel, in accordance with local electrical standards, wiring regulations and requirements of local power authorities.
- To avoid electric shock, DC input and AC output of the inverter must be terminated at least 10 minutes before performing any installation or maintenance.
- The temperature of some parts of the inverter may exceed 60°C during operation, do not touch the inverter during operation to avoid being burnt.
- Ensure children are kept away from inverters.
- Take appropriate measures to avoid electric shock.
- Don't open the front cover of the inverter. Apart from performing work at the wiring terminal, touching or changing components without authorization may cause injury to people, damage to inverters and annulment of the warranty.
- Ensure the output voltage of the proposed PV array is lower than the maximum rated input voltage of the inverter; otherwise the inverter may be damaged and the warranty annulled.
- When exposed to sunlight, the PV array generates dangerous high DC voltage. Please operate according to our instructions, or it will result in danger to life.
- Don't insert or pull the terminals when the inverter is running.

2 Product Introduction

2.1 Overview

The three-phase grid-tied PV inverter converts the DC generated by PV panels into three-phase alternating current and is delivered to the grid.

This series inverter is an important part of PV system and it is suitable for household use, commercial roof, fishing light, and agricultural light and more scenarios.

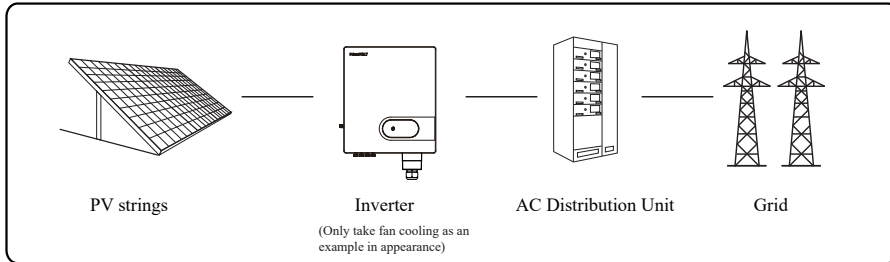

Inverters have been tested as per AS/NZS 4777.2:2020 for three phase combinations.

This series inverter is suitable for TN-S, TN-C, TN-C-S and TT grid system, Refer to the following figures:

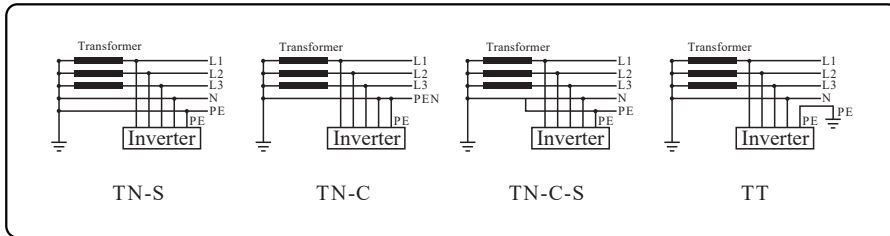

2.2 Model Definition

Model number descriptions(using 10KTL-D3/G2, 10KTL-D3/G2P as an example):

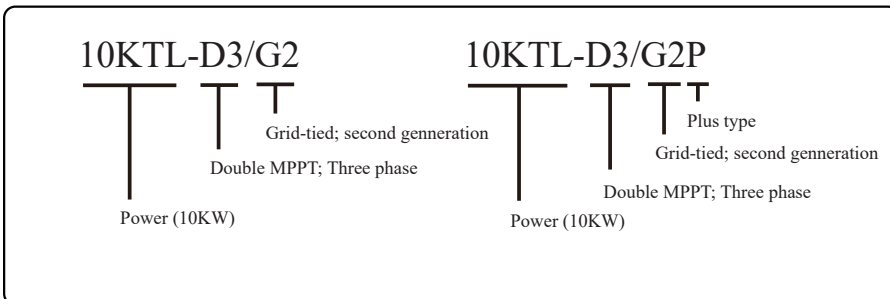

2.3 Product Appearance

The following is only for reference, specific please in kind prevail.

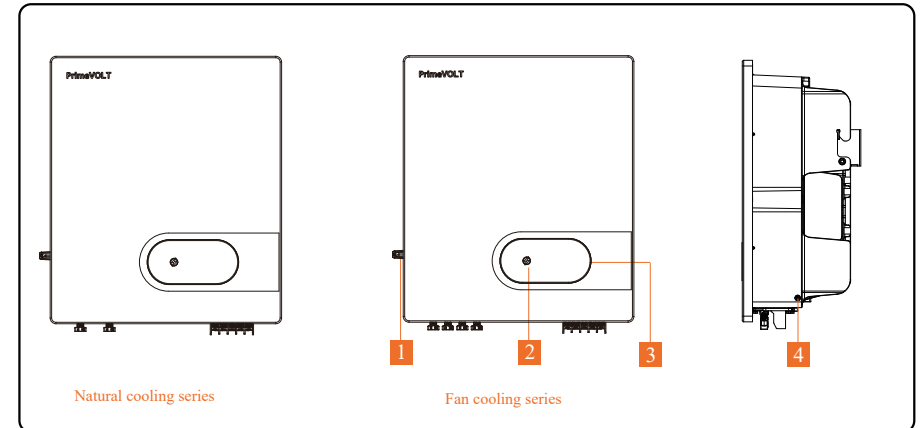
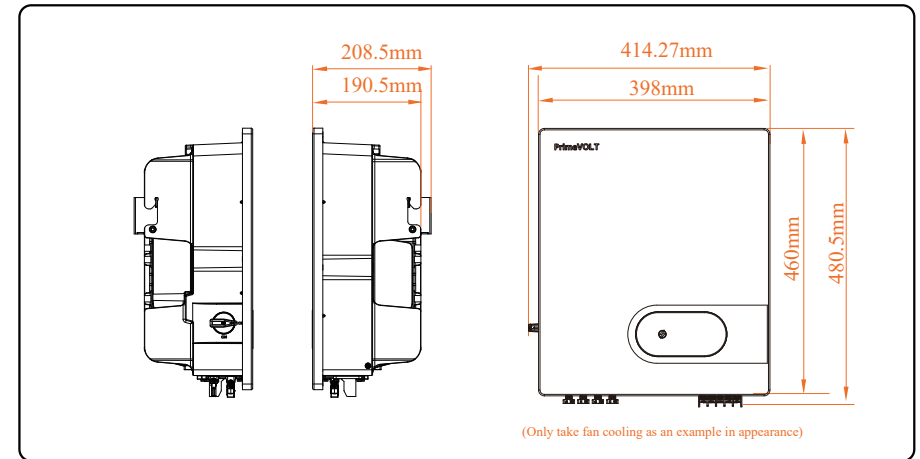

Number	Description
1	DC Switch
2	LED Indicators
3	LCD Screen(Optional)
4	External ground terminal

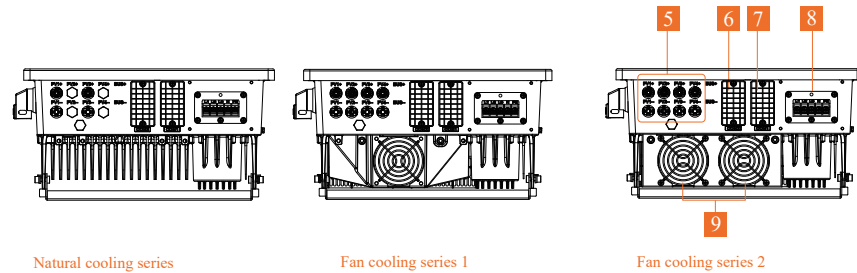

Natural cooling series

Fan cooling series 1

Fan cooling series 2

Number	Description
5	PV terminal
6	RS485 communication port
7	WiFi/GPRS model communication port (Optional)
8	AC output port
9	External fan (It is only suitable for Fan cooling series)

3 Unpack and Storage

3.1 Unpack and Check

Complete test and strict inspection before the inverter is sent out.

When receiving the inverter, check that the packing materials are intact.

After unpacking, examine the PV inverter and its fittings for damage and check that the deliverables are complete.

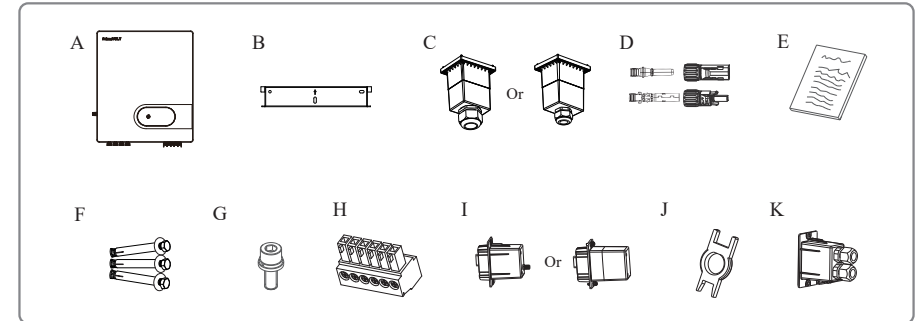

Number	Description	Quantity
A	The Inverter	1
B	Bracket	1
C	AC shield(4× M4 security screws)	1
D	PV connectors	2 or 4
E	File package	1
F	Expansion screws groups	3
G	M6 Security screw	2
H	6-Pins terminal	2
I	WiFi/GPRS module (Optional)	1 (Optional)
J	Remove tool for PV connector	1 (Optional)
K	RS485 cover	1



NOTICE

Contact your dealer immediately, if there is any issue found during operation.

3.2 Storage Inverter

If the inverter is not used immediately, please keep the inverter in a specific environment according to the following:

- Do not unpack the inverter and put desiccant in the original box if the PV inverter is unpacked.
- Store temperature range: -25°C ~ +60°C; Relative humidity range: 0~100%.
- When the inverter is placed multi-layered, it can be folded up to four layers.
- Do not position the inverter at a front tilt, excessive back tilt, or side tilt, or upside down.
- Ensure that qualified personnel inspect and test the inverter before use if it has been stored for a long time.

3.3 Identify Inverter

Inverter body label. The following is only for reference,specific please in kind prevail!

Number	Description
1	Product name and modle
2	Product technical parameters
3	SN Barcode
4	Approve and Safety identification

4 Installation

After checking the outer packing, move the PV inverter to the designated installation position horizontally.

CAUTION	<ol style="list-style-type: none"> 1. Please place the inverter horizontally on the foam or other soft pads and ensure that the ports are free of load-bearing pressure to avoid inverter damages or scratches. 2. The inverter is heavy, be careful to prevent the inverter from slipping and hurting the operator when moving the inverter.
----------------	---

DANGER	<p>Ensure there is no electrical connections around ports of the PV inverter before installation.</p>
---------------	---

Inverters have been tested as per AS/NZS 4777.2:2020 for three phase combinations.

4.1 Selecting the Mounting Location

4.1.1 Installation Environment Requirements

- The storage inverter protection class is IP65 and can be mounted indoors or outdoors.
- To ensure optimum operation and long service life, the ambient temperature must be below 50°C.
- Do not install the inverter in a rest area since it will cause noise during operation.
- The inverter carrier must be fire-proof. Do not mount the inverter on flammable building materials.
- Ensure that the wall meets the requirements of the inverter installation.
- Product label and warning symbols shall be clear to read after installation.
- The installation height should be reasonable and make sure it is easy to operate and view the display.
- Please avoid direct sunlight, rain exposure, snow lay up.

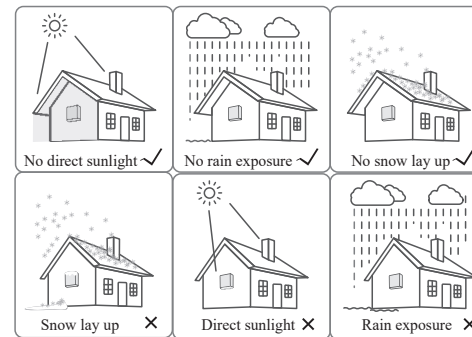

4.1.2 Mounting Requirements

Mount the inverter vertically or tilted backward by max 15°. In order to facilitate the heat dissipation of the inverter.

 NOTICE	The wrong installation mode causes the inverter to be damaged or unable to work properly.
---	---

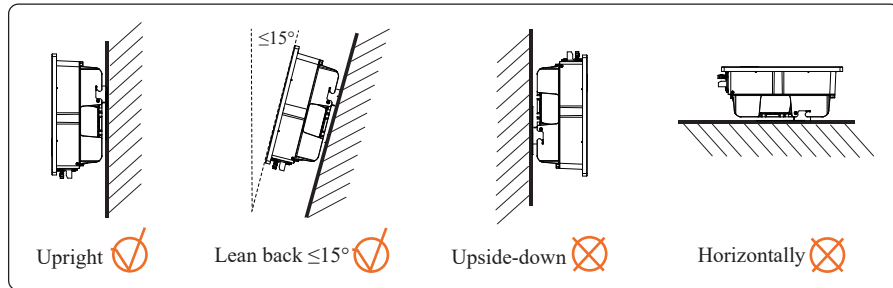

4.1.3 Installation Space Requirements

To ensure the inverter normally and easy to operate, there are requirements on available spaces of the inverter, e.g. to keep enough clearance. Refer to the following figures.

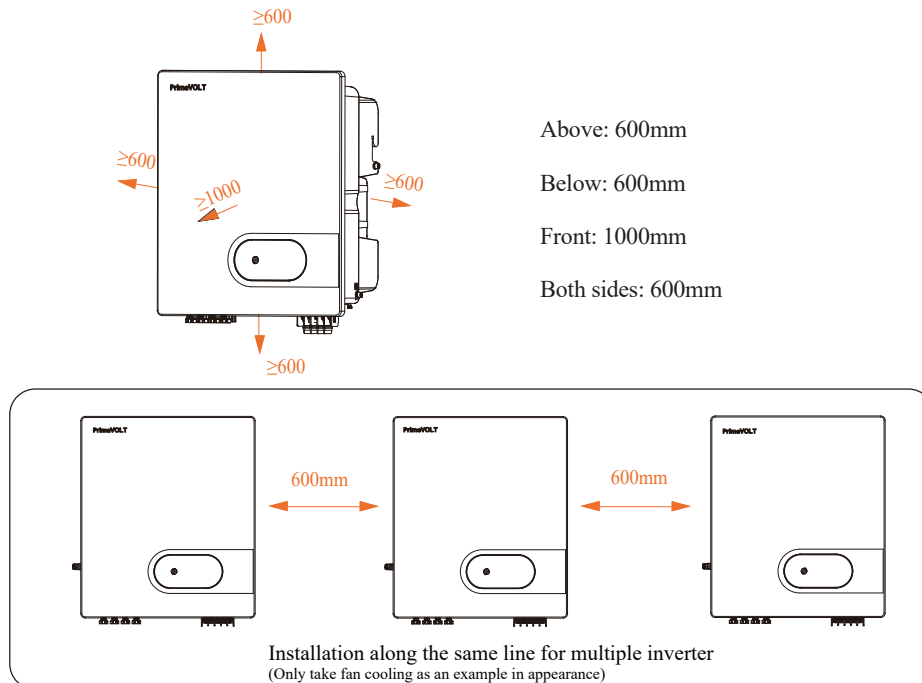

Installation perspective schematic

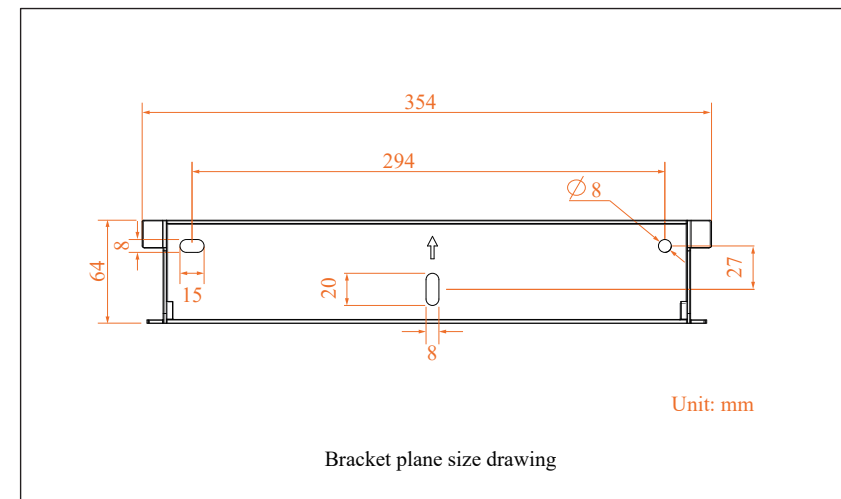
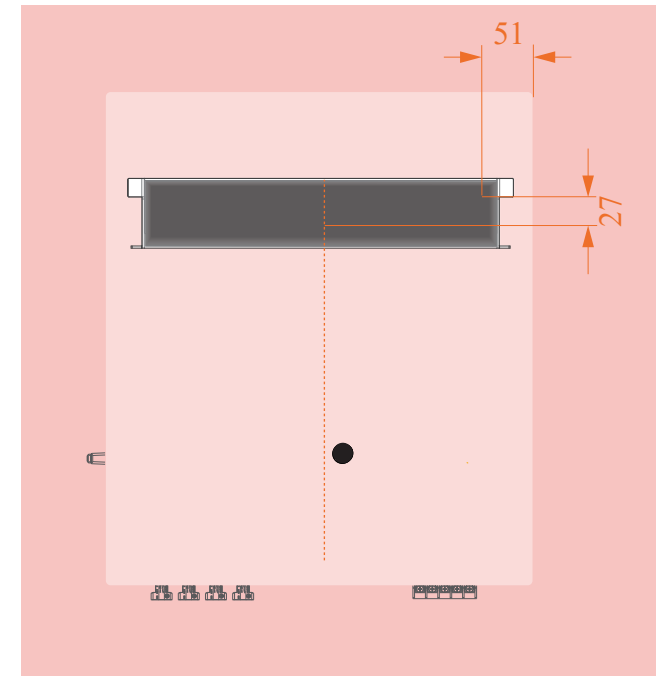

4.2 Mounting

Step 1. Install the mounting bracket



DANGER

1. The walls must be fireproof and non-flammable materials, otherwise there is a fire risk.
2. Before drilling holes, check whether there are electric power pipes buried in the walls to avoid risks.

- 1) Use a horizontally ruler to mark the position of the 3 holes on the wall. Refer to Step 1. And drill 3 holes, 10mm in diameter and 60 mm in deep. Refer to Step 1 and Step 2.
- 2) Knock the expansion screw kit into the hole together with a hammer. Refer to Step 3.
Note: Do not remove the nut unit.
- 3) After tightening 2-3 buckles, the expansion bolts are tight and not loose, and then unscrew the bolts, spring washer, gasket. Refer to Step 3.
- 4) Install the bracket on the wall, the bracket screw is pointed at the expansion tube on the wall, then install the gasket and tighten screw. Refer to Step 4.

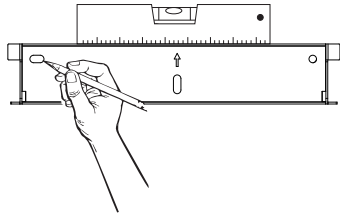

Set bracket horizontally.

- 1 Mark the holes position on the wall.

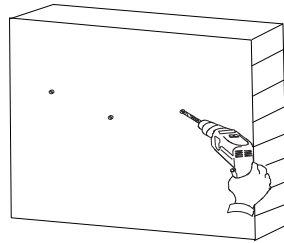

Ø:10mm; Depth: 60mm

- 2 Drill the holes.

Expansion screw group
(M6; 3 sets)

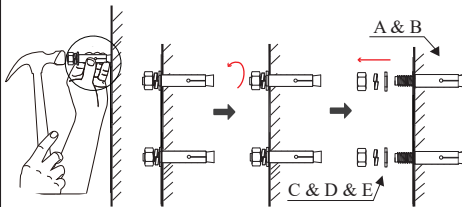
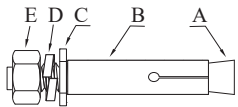

- 3 Install the expansion screw

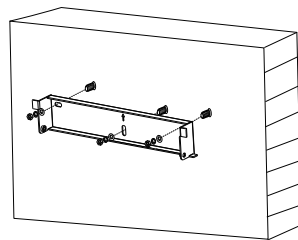

M6 Expansion screws; 2~2.5N.m

- 4 Install bracket.

Step 2. Install the inverter.

Install the inverter on the bracket accurately and tighten the screws at both sides, as shown in Step 5 and Step 6.



CAUTION

To prevent damage of the inverter, please hang the inverter on the bracket and confirm the reverse, do not loosen the handle until the inverter is fixed.

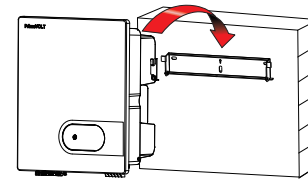

- 5 Install the inverter.

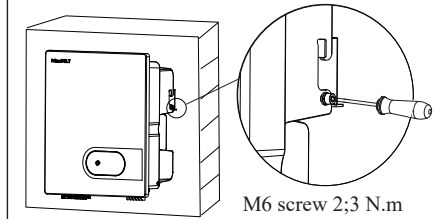

- 6 Tighten the screws at both sides.

5 Electrical Connection

System Connection

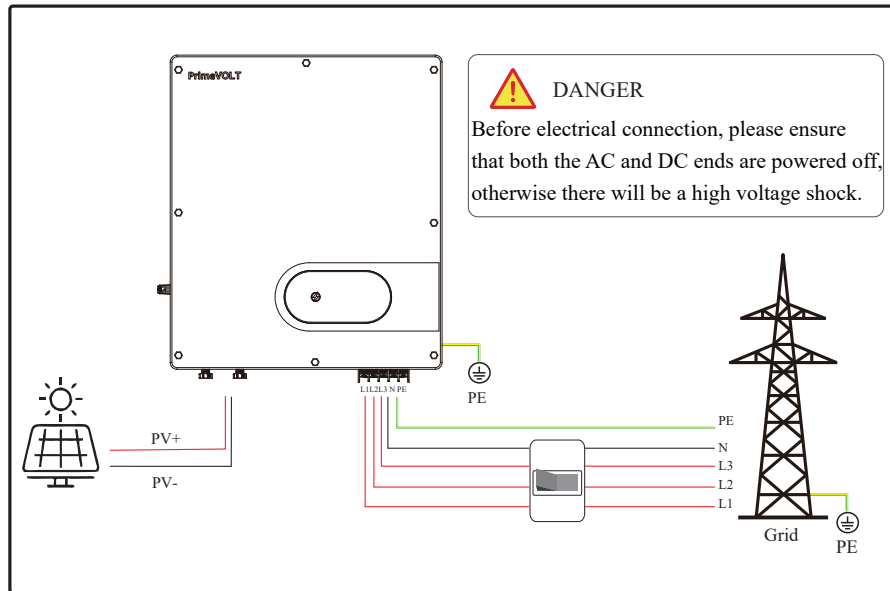

5.1 Grounding

According to the EN50178 requirement, the right side of the device has a protective grounding connection. Be sure to connect the protection ground cable to this port when installing the inverter. The user can perform the ground connection according to the on-site condition.

Step1 Remove an appropriate length using a wire Stripper.

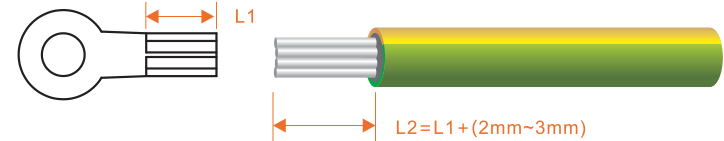

Step2 Insert the exposed core wires into the crimping areas of the OT terminal and crimp them using hydraulic pliers.

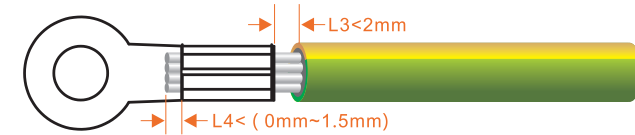

Step3 Remove the ground screws from the ground points.

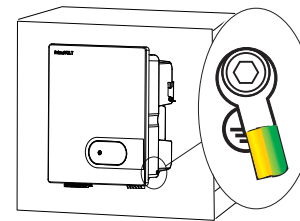

Items	Remark
Screw	M6 × 12mm; 3 N.m
OT Terminal	OT6-6 (5K-15K); OT16-6 (17K-25K)
Yellow green lines	S (Yellow green lines) ≥ S (PE line of DC cable) S is the cross-sectional area.

Ensure that the grounding resistance is less than 10Ω.



WARNING

According to regulations, the secondary protection grounding can't replace the PE terminal connection of the AC cable. Ensure that both are grounded reliably, otherwise, fatal injury can occur due to the high voltage.



CAUTION

If the positive pole or negative pole of the PV array is required to be grounded, then the inverter output (to AC grid) must be isolated by transformer in accordance with IEC63109-1,-2 standards.

5.2 AC Connection

5.2.1 AC cable connection

1. Measure and access the voltage and frequency of the point to ensure that it meets the grid-tied specifications of the inverter.
2. PE wire(GND) must be well grounded to ensure that impedance between Neutral wire and Earth wire be less than 10Ω.
3. Disconnect the circuit breaker or fuse from the inverter and grid-connected access point.
4. Use the copper wire.
5. Follow these steps.

No.	Name	Model	5K-15K	17K-20K	22K-25K
A	Wire outer diameter(mm)		11-18	24-32	24-32
B	Cross-sectional area(mm ²)	Range	4-6	6-16	10-1
		Recommended	6	10	16

Note: It is recommended to use outdoor dedicate cables with multiple copper cores.

1 Select proper AC cables and OT terminals (5 wires).

Heat shrinkable tube

Unscrew the nut of the cover and thread the AC cable (5 wires) cross the nut, threaded sleeve and the cover. Then crimp the OT terminal and use heat shrink tubing or insulation tape for protection.

2 Wires threading and pressing.

3 Lock the AC cable to the corresponding AC terminals.

Screw	Torque	D
5K-15K	M4	1.5N·m 10mm
17K-25K	M5	3N·m 12.5mm

(Only take 25k modle as an example)

The RCD used on the main solar supply circuit should be Type A 100mA. This and all associated wiring must be installed in accordance with AS /NZS 4777.1

	Nut	Torque
5K-15K	M25	5.5N·m
17K-25K	M40	12N·m

① 4*M4 screws; 1.2N·m

4

- ① Align the AC cover with the 4 holes and tighten it firmly with 4×M4 screws.
- ② Fasten the nut (waterproof cap).

5.2.2 AC Breaker and Leakage current protector

To ensure that the inverter disconnect from the grid of safely, the independent AC breaker must be configured for each inverter as a protective device.

WARNING

- Multiple inverters are not allowed to share a circuit breaker.
- Load is not allowed to connect between the inverter and the AC breaker.

Inverter Model	Recommended Value
PV 5KTL-D3/G2,PV 6KTL-D3/G2, PV 8KTL-D3/G2	20A
PV 10KTL-D3/G2,PV 10KTL-D3/G2P, PV 12KTL-D3/G2,	32A
PV 15KTL-D3/G2, PV 15KTL-D3/G2P PV 17KTL-D3/G2	40A
PV 20KTL-D3/G2	50A
PV 22KTL-D3/G2, PV 25KTL-D3/G2	63A

Internal current detection equipment for inverter, the inverter detects the leakage of the power grid that is greater than the reduced value, and will be disconnected quickly from the power grid. If the external installation leakage protection device is installed, its action current must be greater than equal to 100mA.

5.3 DC Connection

 DANGER	<ul style="list-style-type: none"> PV modules generate electric energy when exposed to sunlight and can create an electrical shock hazard. Therefore, when connecting the PV modules, shield them with opaque cloth and ensure that DC switches are OFF. To avoid electric shock, don't touch the charge part and connect the terminals carefully. Before connecting power cables, ensure the AC/DC switches are OFF. When the inverter is connected to the grid, don't plug in or plug out the PV strings. Don't perform any operation until the inverter is shut down.
---	--

 WARNING	<ul style="list-style-type: none"> PV modules connected in series in each PV string must be of the same specifications. The maximum open-circuit voltage of each PV string must be always lower than or equal to its permitted range. The maximum short circuit current of each PV string must be always lower than or equal to its permitted range. Ensure that the positive and negative terminals of each PV strings connected to the inverter correctly. The positive or negative terminals of PV strings can't be connected with short circuit. The total output power of all PV strings can't exceed the maximum input power of the inverter.
--	---

 NOTICE	<ul style="list-style-type: none"> The positive and negative terminals of PV modules can't connect to PE wire (GND), otherwise, the inverter will be damaged. Ensure that the voltage of each PV string doesn't exceed 1100V under any circumstances. When the input voltage is 1000V to 1100V, the inverter will enter the standby state. When the voltage returns to the MPPT operating voltage, namely 160V-1000V, the inverter will return to the normal state.
---	--

5.3.1 Preparation

Different PV module input configuration module table (All PV strings are connected to the inverter in the corresponding groups number)

Inverter module	PV input configuration
PV 5KTL-D3/G2, PV 6KTL-D3/G2	PV strings circuit<15A, All PV strings are connected into a group
PV 8KTL-D3/G2, PV 10KTL-D3/G2	PV strings circuit<12A, All PV strings are connected into two groups PV strings circuit>12A, All PV strings are connected into a group
PV 12KTL-D3/G2, PV 15KTL-D3/G2	PV strings circuit≤15A, All PV strings are connected into two groups
PV 10KTL-D3/G2P, PV 12KTL-D3/G2P PV 15KTL-D3/G2P	PV strings circuit≤15A, All PV strings are connected into two groups PV strings circuit>15A, All PV strings are connected into a group
PV 17KTL-D3/G2, PV 20KTL-D3/G2	PV strings circuit<12A, All PV strings are connected into four groups PV strings circuit≥12A≤15A, All PV strings are connected into three groups PV strings circuit>15A, All PV strings are connected into two groups
PV 22KTL-D3/G2, PV 25KTL-D3/G2	All PV strings are connected into four groups

Before connecting the PV input to the inverter, ensure that the package meets the following electrical specifications.

Inverter module	Limit of each input open-circuit voltage	Maximum allowable input terminal current
All	1100V	20A

Open-circuit voltage altitude derating curve of the inverter as shown in the following figure.

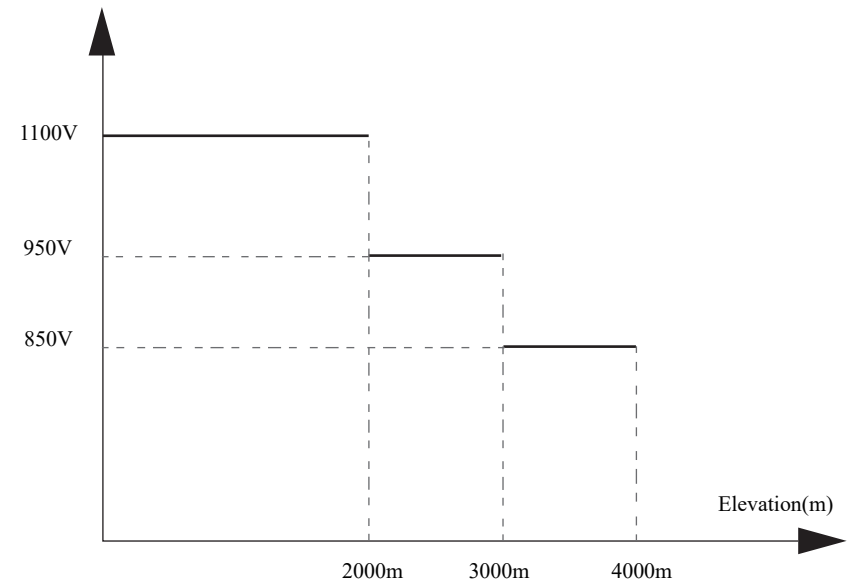

Open-circuit voltage altitude derating curve of the inverter

 NOTE	<p>To ensure that the inverter reaches the enclosure of IP65, it can only use the connector provided by supply.</p>
---	---

5.3.2 Connection

PV connection please refer to below.

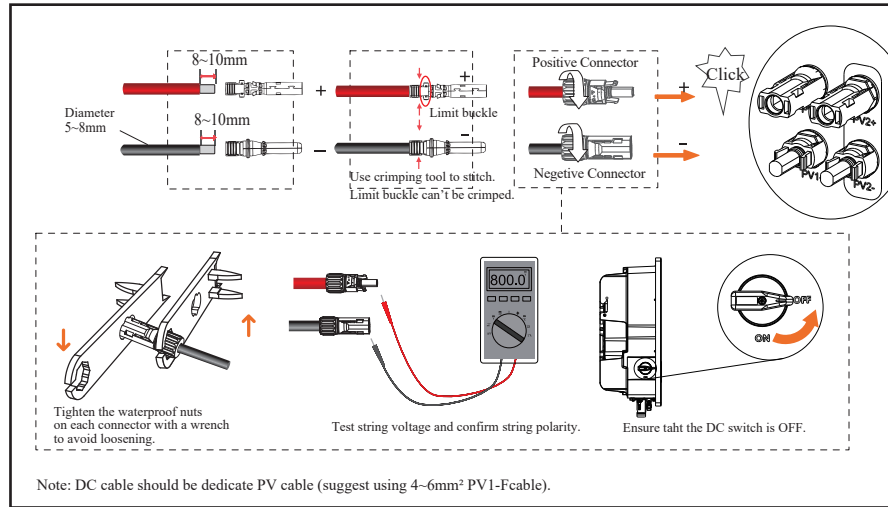

5.4 Communication Connection

5.4.1 Communication Mode Description

You can use the following communication modes to implement communication: Bluetooth, WIFI, GPRS and RS485 all of which are described as follows.

- **Bluetooth Module**
You can turn on the Bluetooth function of the mobile phone, and set parameters and monitor data of the inverter through the mobile APP.
- **WiFi/GPRS/RS485 Modules**
Through DB9 communication interface is transferred to other communication modules to monitor the inverter, the module and functions are shown in Table 5.4.

Module	Function description
WIFI	WIFI module implements communication with Cloud server through wire and wireless network to monitor PV inverter's data status. For more details, refer to WIFI Product Application Manual.
GPRS	GPRS module implements communication with Cloud server through wire and wireless network to monitor PV inverter's data status. For more details, refer to GPRS Product Application Manual.
RS485	RS485 switching module monitors PV inverter's data status through collecting and uploading data to Cloud server.

Table 5.4 Communications module description

5.4.2 WIFI/GPRS Module Connection(Optional)

WiFi/GPRS module connection please refer to below.

For details about APP settings, see the WIFI/GPRS Module Installation Guide in the packing case.

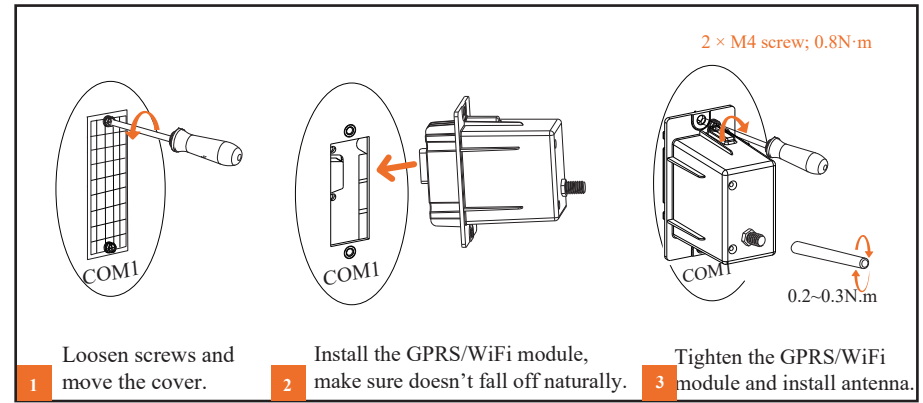

5.4.3 RS485 Installation

The multiple inverter network and RS485 communication is as follows:

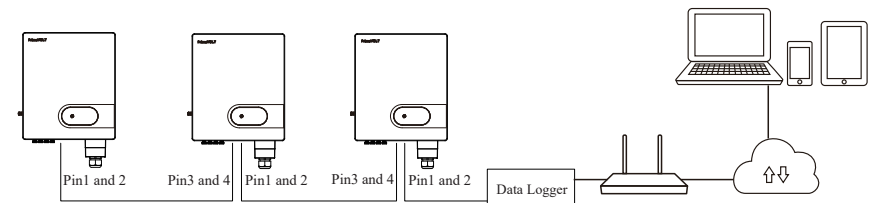

Install RS485 following this steps:

- Step1 Loosen screws and remove the cover plate.
- Step2 Wires making, threading and wiring.
- Step3 Insert the 6-Pin terminal into the RS485 communication port.
- Step4 Install the RS485 cover.
- Step5 RS485 communication address setting.

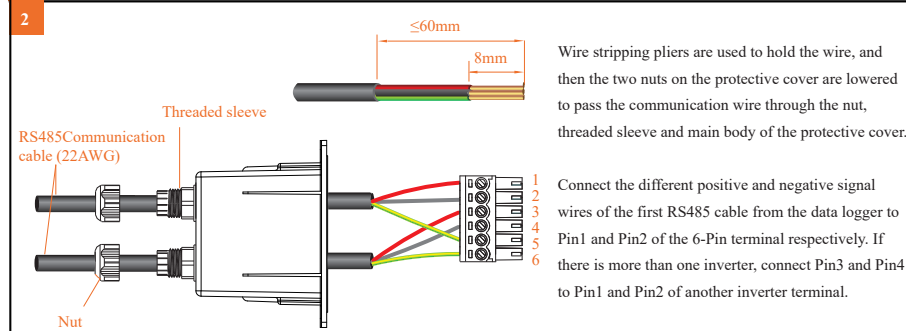
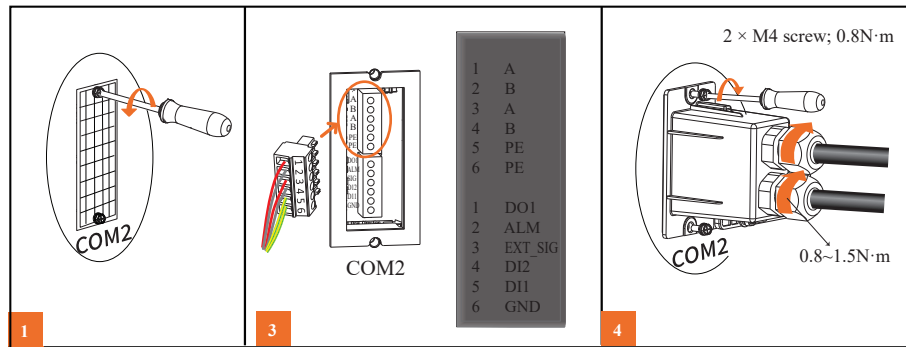

Connect the different positive and negative signal wires of the first RS485 cable from the data logger to Pin1 and Pin2 of the 6-Pin terminal respectively. If there is more than one inverter, connect Pin3 and Pin4 to Pin1 and Pin2 of another inverter terminal.

5

- Download the APP in either of the following ways
 - Scan the QR code on the inverter to download the APP
 - Download the APP from the APP store or Google Play.

Note: You need to grant all access rights in all pop-up windows when installing the APP or setting your phone.
- Power on the inverter.
- Connect the inverter. Open the bluetooth on your phone, then open the APP. Then follow the instructions below:

④ Go to Console>Communication Setting > RS485 Setting > Modbus Page, check the Modbus address (the default value is 1), and click to modify the address as required if necessary.

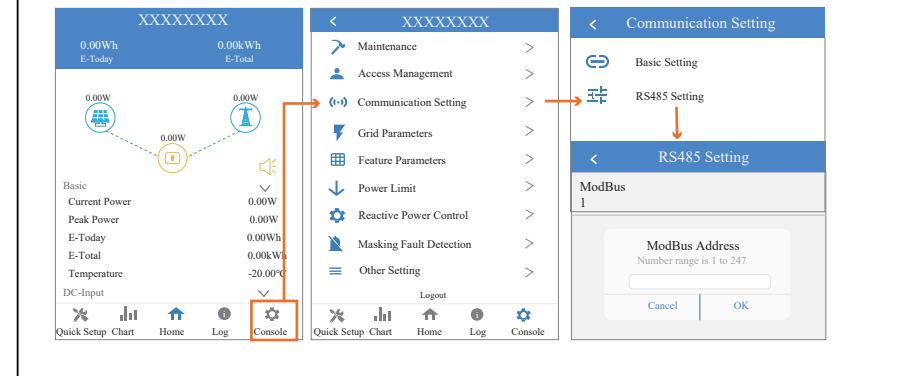

5.4.2 Country code configuration (only for Administrator)

Go to Console > Grid Parameters page. Follow the steps below to configure the country code for Australia only for Administrator status.

Note:
For Australian Market: Region settings must be selected during commissioning. To comply with AS/NZS 4777.2:2020, please select from Region A/B/C. Please contact your local electricity grid operator on which region to select.

5.5 Power limit (optional)

5.5.1 Wiring diagram of Inverter+Meter

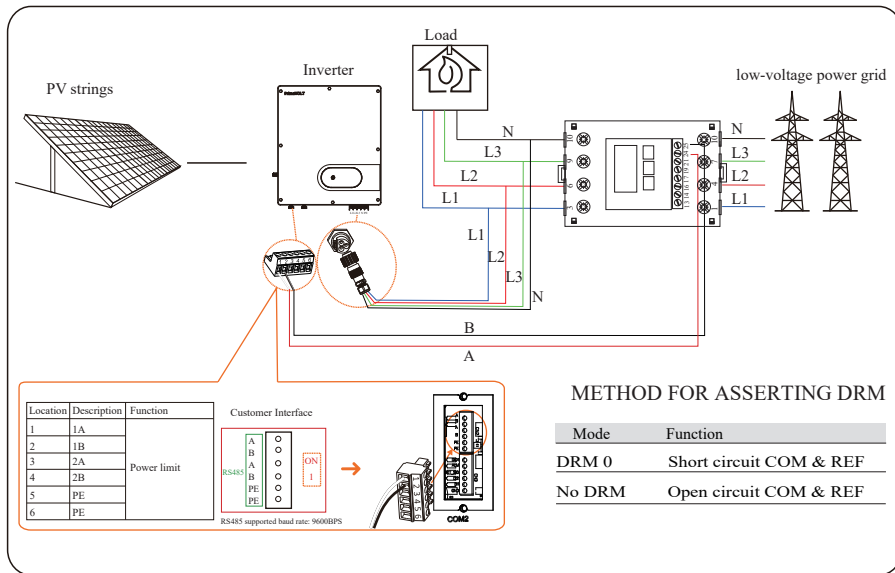

- Set the “Power limit function” to “Digital Power Meter”
- Set the Digital Power Meter Type
- Set the meter position base on the meter installed on load or on grid
- Set maximum feed-in grid power if needed
- Set “Power limit CT ratio” only when using inverter+CT

When “Power limit function” is set to “Digital Power Meter”, the RS485 of inverter will change to a Host that will communicate with digital meter using ModbusRTU Protocol (9600 BPS, 8 data bit, 1 stop bit, no parity data format) through communication address 1. Please make sure that the meter is set to Modbus-RTU, 9600, 8-N-1 with address 1. For details of digital meter setting operation, please refer to the meter user manual.

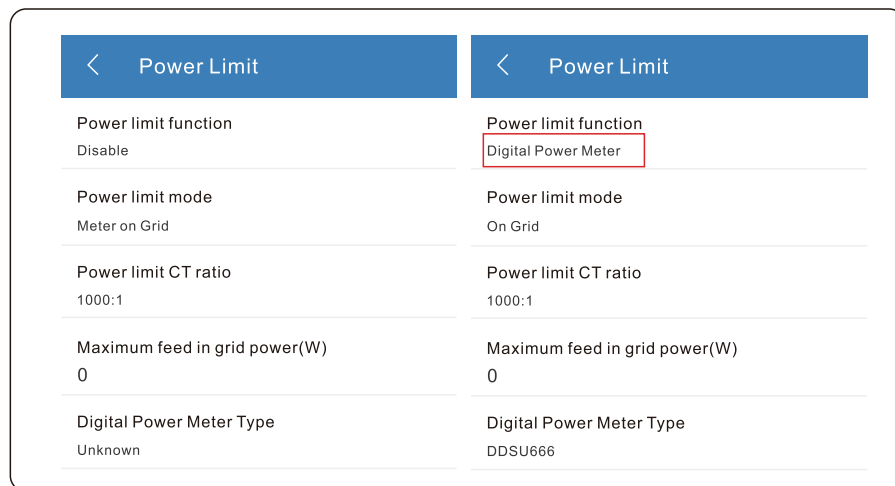

6 Startup/Shutdown Procedure

6.1 Check before startup/shutdown Procedure

Check following this steps after installation.

No.	Items
1	The inverter is firmly installed.
2	There is enough heat dissipation space, no external objects or parts left on the inverter.
3	It is convenient for operation and maintenance.
4	The wiring of the system is correct and firm.
5	Check whether the DC and AC connection are correct with a multimeter, and whether there is a short circuit, break, or wrong connection.
6	Check whether the waterproof nuts of each part are tightened.
7	The vacant port has been sealed.
8	All safety labels and warnig labels on the inverter are complete and complete without occlusion or alteration.

6.2 Startup Procedure

Startup procedure following the procedures :

Supply Main Switch
See if there's any on site
(The figure is only for reference)

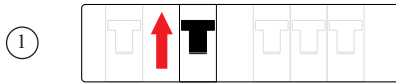

AC Circuit Breaker
Switch to ON
(The figure is only for reference)

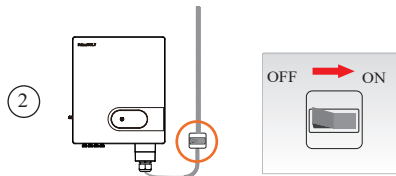

DC Switch
Switch to ON

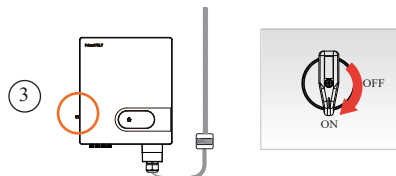

LED icon
Blue on (normal status)

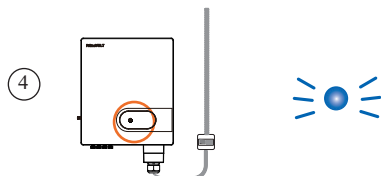

Finishing
Your system has started up

5

6.3 Shutdown Procedure

It may be necessary to shut down the inverter sometimes during the daily use. If necessary, please follow the procedures:

Supply Main Switch
See if there's any on site
(The figure is only for reference)

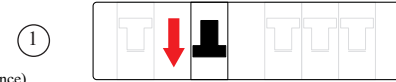

AC Circuit Breaker
Switch to OFF
(The figure is only for reference)

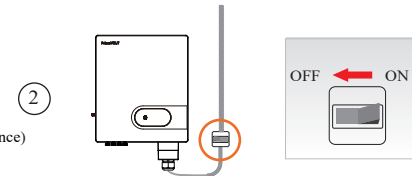

DC Switch
Switch to OFF

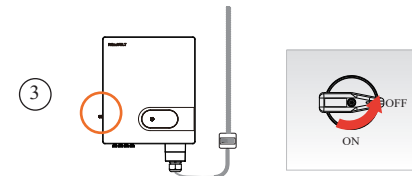

Wait at least 5 minutes
Let inverter fully
heat dissipation.



Finishing
Your system has shutdown

5



WARNING

After the inverter is powered off, the heat sink generates heat and there is excess electricity in the inverter. To avoid electric shocks and burns, powered off inverter for at least five minutes before performing operations.

7 User Interface

Inverter display panel is consist of LED icon and LCD(Optional).

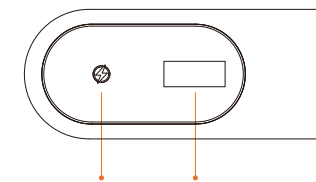

LED icon LCD(Optional)

LED status	Descriptions	LED status	Descriptions
Blue led blink slowly 1s/time	Standby or startup state (not connected to the grid)	Red led blink slowly 1s/time	Output side fault
Blue on	Grid-tied status	Red led blink quickly 0.25s/time	Output side fault
Green on	Power limited status	Red led on	System internal fault
		Red/Green/Blue light alternately (1 color /0.25s)	Burning code(Master/Slave) Control power set up (lasts 1second)

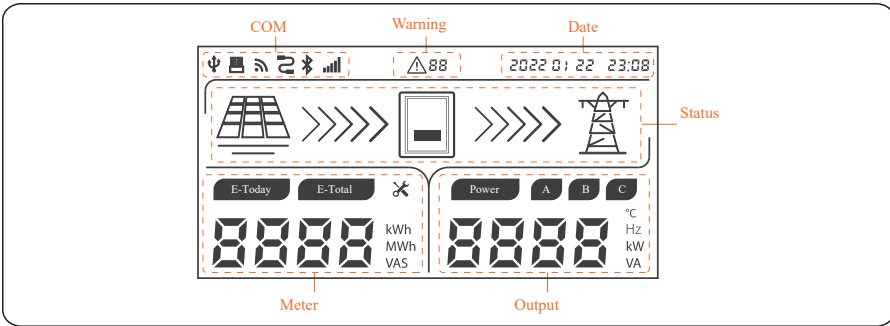

COM

When WIFI/GPRS/Bluetooth is transferring data, icon will be ON, while no data transmission, the icon will be off after 10s. When RS485 is transferring data, icon will be ON, while no data transmission, the icon will be off after 10s.

Warning

When warning is triggered, icon will be illuminated: from left to right the first bit could be A/ B/ C, it stands for warning type, and the second bit is warning code, please refer to warning code in table for details.

Date

When external communications is normal and time zone is set correctly, the built-in clock of inverter will be synchronized with server's time. Without external communications, it is recommended to use the mobile app to set up time through connecting bluetooth to the inverter.

Status

Icon stands for PV strings, when inverter is standby status, MPPT voltage of the PV string will be displayed in Meter zone.

Icon stands for grid, when voltage and frequency of power grid is in normal range, the icon keeps on, or else, it blinks; when there is no voltage, the icon will be off.

Icon stands for energy flow, when inverter is in normal status, the icon will be on, or else it will be off.

Meter

Normal status: today and total energy, MPPT voltage and current are showed in turn.	
Standby status: counter down value before inverter start up.	
Any status: setting parameters via APP, the screen keep for 5 seconds.	
Normal status: output power, grid voltage and current are showed in turn.	

Warning Table

Status	Details	Warning code
Red led blink (slowly) 1s every times	Grid over voltage	A0
	Grid under voltage	A1
	Grid absent	A2
	Grid over frequency	A3
	Grid under frequency	A4
	Grid unbalance	A6
	Grid over mean voltage	A7
Red led blink (slowly) 0.25s every times	PV over voltage	B0
	Insulation resistance abnormal (Earth Fault)	B1
	Leakage current abnormal (Earth Fault)	B2
	Strings abnormal	B3
Red led blink (slowly) 0.25s every times	PV under voltage PV	B4
	Control power abnormal	C0
	Electric arc abnormal	C1
	DC bias current abnormal	C2
	Inverter relay abnormal	C3
	Inverter over temperature	C5
	Leakage current HCT abnormal	C6
	System fault	C7
	DC link voltage unbalance	C9



Status	Details	Warning code
Red led on	DC-link over voltage	CA
	Internal communication error	CB
	Software version incompatibility	CC
	EEPROM fault	CD
	Sampling inconsistency	CE
	Invert circuit abnormal	CF
	Boost circuit abnormal	CG
/	Data logger lost	CH
	Meter lost	CJ
	Fan abnormal	C8
	Remote off	CN

Note: If you select a machine with a LCD screen, the warning code will be displayed on the LCD screen. Non-lcd screen models need to enter the app to view the corresponding warning code.

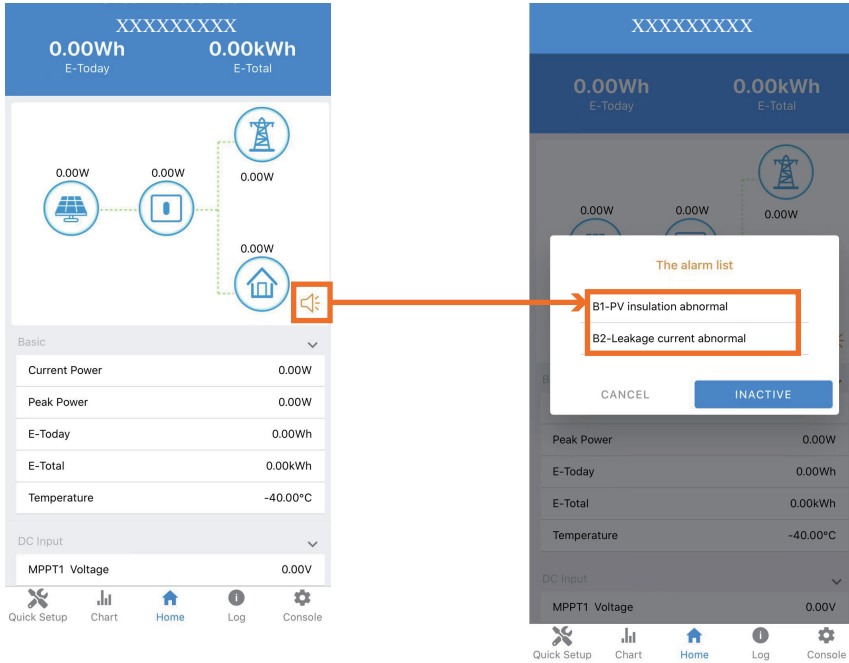
If the Inverter is malfunctioning, a small horn symbol will appear in the APP interface. You can get specific fault information by clicking on the small horn symbol as below images.



8 Troubleshooting and Maintenance

 WARNING	Before maintaining and commissioning inverter and its peripheral distribution unit, switch off all the charged terminals of the inverter and wait at least 10 minutes after the inverter is powered off, otherwise there will be a high voltage shock.
 DANGER	<ul style="list-style-type: none"> Wrong maintenance will result in personnel injury or equipment damage! Before performing any maintenance operations, you must follow these steps: First, disconnect the AC circuit breaker on the grid side, and then disconnect the DC switch. Wait at least 10 minutes after the inverter is powered off, otherwise there will be a high voltage shock. Use testing equipment to make sure there no voltage or current.
 NOTICE	<ul style="list-style-type: none"> Comply with ESD protection specifications and power distribution ESD bracelets. Avoid unnecessary contact with the circuit board. Touching printed circuit boards or other electrostatic sensitive components may cause damage during the process.

8.1 Troubleshooting

If the inverter is break down, the LED indicator will turn to red.

Alarm Information	Measures Recommended
A0-Grid over voltage	<ol style="list-style-type: none"> If the alarm occurs accidentally, possibly the power grid is abnormal accidentally. No extra action is needed. If the alarm occurs repeatedly, contact the local power station. After receiving approval of the local power bureau, revise the electrical protection parameters setting on the inverter through APP. If the alarm persists for a long time, please confirm: <ol style="list-style-type: none"> The AC circuit breaker does not jump frequently (the instantaneous high pressure); If the line of communication is followed by the user manual, the cable impedance will cause the power grid to rise; The three-phase machine measures whether the voltage between the zero line and the ground line exceeds 30V; More than the wiring of the grid; If there is no problem, Pls. contact the customer service center.
A1-Grid under voltage	<ol style="list-style-type: none"> If the alarm occurs accidentally, possibly the power grid is abnormal accidentally. No extra action is needed. If the alarm occurs repeatedly, contact the local power station. After receiving approval of the local power bureau, revise the electrical protection parameters setting on the inverter through APP. If the alarm persists for a long time, please confirm: <ol style="list-style-type: none"> AC circuit breaker is disconnect or not; Whether the AC circuit breaker is damaged (whether the voltage in the closed state is consistent with the voltage of the outlet); The AC terminals are in good contact. If the actual measuring voltage is within the specification range, please contact the customer service report repair.

A2-Grid absent	<p>1.If the alarm occurs accidentally, possibly the power grid is abnormal accidentally. No extra action is needed.</p> <p>2. If the alarm occurs repeatedly, contact the local power station. After receiving approval of the local power bureau, revise the electrical protection parameters setting on the inverter through APP.</p> <p>3.If the alarm persists for a long time,please confirm:</p> <p>1) AC circuit breaker is disconnect to not;</p> <p>2) Whether the AC circuit breaker is damaged (whether the voltage in the closed state is consistent with the voltage of the outlet);</p> <p>3) The AC terminals are in good contact;</p> <p>4) Whether the power supply line failure.</p> <p>If exclude all possibility, please contact the customer service report repair.</p>
A3-Grid over frequency	<p>1.If the alarm occurs accidentally, possibly the power grid is abnormal accidentally. No extra action is needed.</p> <p>2.If the alarm occurs repeatedly, contact the local power station. After receiving approval of the local power bureau, revise the electrical protection parameters setting on the inverter through APP.</p>
A4-Grid under frequency	<p>1.If the alarm occurs accidentally, possibly the power grid is abnormal accidentally. No extra action is needed.</p> <p>2.If the alarm occurs repeatedly, contact the local power station. After receiving approval of the local power bureau, revise the electrical protection parameters setting on the inverter through APP.</p> <p>3.If the alarm persists for a long time, please contact the customer service center.</p>
A6-Grid abnormal (Only for three-phase inverter)	<p>1.If the alarm occurs accidentally, possibly the power grid is abnormal accidentally. No extra action is needed.</p> <p>2.If the alarm occurs repeatedly, please confirm:</p> <p>1) The three-phase voltage is measured, and confirm the three-phase voltage imbalance is more than 30%, please improve the power supply condition of the power grid company.</p> <p>2) The three-phase AC circuit breaker is damaged or not (whether the voltage of the inlet line and the outlet of the outlet is consistent).</p> <p>3) The AC circuit breaker have zero line or not, and if the line is cut off, the short zero line confirmation problem is repeated. If not again, replace 3Pole switch or the zero line is short. If still, please contact customer service report repair.</p>
B0-PV over voltage	Check whether the maximum voltage of a single string of input PV modules exceeds the MPPT voltage range. If the maximum voltage is higher than the standard voltage, modify the number of PV module connection strings.
B1-PV insulation abnormal (Earth Fault)	<p>1.If the alarm occurs accidentally, the inverter can generate power. Check the installation environment is wet or not of the component and wire rope,and improve the installation environment.</p> <p>2..If the alarm occurs repeatedly, the inverter can generate electricity occasionally. Check whether the positive and negative polarity of the pv component is short circuit, and check the component is damaged or the connection line is broken.</p> <p>3.If the alarm continues, equipment cannot generate power, please contact customer service report repair.</p>
B2-Leakage current abnormal (Earth Fault)	<p>1.If the alarm occurs accidentally, the inverter can generate power, which may cause the power grid to cause the inverter to automatically recover. No extra action is needed.</p> <p>2.If the alarm occurs frequently, and is accompanied by an insulation impedance alarm. Check the abnormal alarm of the insulation.</p> <p>3. If the alarm continues, the equipment cannot generate electricity, please contact the customer service report repair.</p>
B4-PV under voltage	<p>1.If occurs when the light is weak(such as the early morning or evening, and the extreme weather of rain and dust storms), the component voltage is lower than normal. No extra action is needed.</p> <p>2.If there is a weak condition of light, please check the group to have a short circuit and open circuit or not.</p>
B5-PV irradiation wea	Normal phenomena under light weak conditions. No extra action is needed.
B7-PV string reverse	Check and modify the positive and negative polarity of the input of the circuit string.

C0-Internal power supply abnormal	<p>1. If the alarm occurs occasionally, the inverter can be automatically recovered and no action is required.</p> <p>2. If the alarm occurs repeatedly, the inverter cannot work properly. Please contact the customer service center.</p>
C2-Inverter over dc bias current	<p>1. If the alarm occurs occasionally, the inverter can be automatically recovered and no action is required.</p> <p>2. If the alarm occurs repeatedly, the inverter cannot work properly. Pls.contact the customer service center.</p>
C3-Inverter relay abnormal	<p>1. If the alarm occurs occasionally, the inverter can be automatically recovered and no action is required.</p> <p>2. If the alarm occurs repeatedly, the single-phase inverter, please check whether the live line and zero line of the contact connection is reversed; the three-phase inverter check the live line to zero line and the voltage of the live line to the ground. If the grid side is normal, please contact the customer service report repair.</p>
C5-Inverter over temperature	<p>1. If the alarm occurs occasionally, the inverter can be automatically restored, no action required.</p> <p>2. If the alarm occurs repeatedly, pls. check the installation site for direct sunlight, good ventilation, and high ambient temperature (Such as installed on the parapet). If the ambient temperature is lower than 45° C and the heat dissipation is good, contact the customer service center.</p>
C6-GFCI abnormal	<p>1. If the alarm occurs occasionally, it could have been an occasional exception to the external wiring, the inverter can be automatically recovered, no action required.</p> <p>2. If it occurs repeatedly or cannot be recovered for a long time, pls.contact customer service to report repair.</p>
C7-System type error	If the alarm occurs, the inverter can not work, please restart the inverter. If the alarm continues, please contact customer service to report repair.
C8-Fan abnormal	<p>1. If the alarm occurs occasionally, please restart the inverter.</p> <p>2. If it occurs repeatedly or cannot be recovered for a long time, check whether the external fan is blocked by foreign objects. Otherwise, contact customer service.</p>
C9-Unbalance De-link voltage	<p>1. If the alarm occurs occasionally, the inverter can be automatically recovered and no action is required.</p> <p>2. If the alarm occurs repeatedly, the inverter cannot work properly. Please contact the customer service center.</p>
CA-Dc-link over voltage	<p>1. If the alarm occurs occasionally, the inverter can be automatically recovered and no action is required.</p> <p>2. If the alarm occurs repeatedly, the inverter cannot work properly. Please contact the customer service center.</p>
CB-Internal communication error	<p>1. If the alarm occurs occasionally, the inverter can be automatically recovered and no action is required.</p> <p>2. If the alarm occurs repeatedly, the inverter cannot work properly. Please contact the customer service center.</p>
CC-Software incompatibility	<p>1. If the alarm occurs occasionally, the inverter can be automatically recovered and no action is required.</p> <p>2. If the alarm occurs repeatedly, the inverter cannot work properly. Please contact the customer service center.</p>
CD-Internal storage error	<p>1. If the alarm occurs occasionally, the inverter can be automatically recovered and no action is required.</p> <p>2. If the alarm occurs repeatedly, the inverter cannot work properly. Please contact the customer service center.</p>
CE-Data inconsistency	<p>1. If the alarm occurs occasionally, the inverter can be automatically recovered and no action is required.</p> <p>2. If the alarm occurs repeatedly, the inverter cannot work properly. Please contact the customer service center.</p>
CF-Inverter abnormal	<p>1. If the alarm occurs occasionally, the inverter can be automatically recovered and no action is required.</p> <p>2. If the alarm occurs repeatedly, the inverter cannot work properly. Please contact the customer service center.</p>
CG-Boost abnormal	<p>1. If the alarm occurs occasionally, the inverter can be automatically recovered and no action is required.</p> <p>2. If the alarm occurs repeatedly, the inverter cannot work properly. Please contact the customer service center.</p>

Remote monitoring data is not updated	If this phenomenon occurs occasionally, it will not be used for communication signals. If long time data is not updated, pls.contact customer service report repair.
Remote monitoring shows the inverter icon is yellow	1.The inverter is normal, the communication is short, and the data is in the data. This state does not need to be processed. 2.The inverter is normal and is in a mater, please check whether the inverter is normal and the ac switch is closed.
No display of the inverter indicator	Confirm whether the input voltage of the inverter is normal, if the input voltage is less than 120V. Check the component, and if the voltage is normal, contacting the customer service report repair.
Low power generation	1.Check the electricity generation on the meter and confirm whether the data is consistent with the monitoring data; 2.Cherk components, avoid components because of the loss of the power generation caused by occlusion, dust, breakage, etc. 3.Check the monitoring data to confirm whether the inverter is exposed to the network because the alarm is frequently removed, And if there is a warning, the alarm shall be handled accordingly.

8.2 Maintenance

Routine Maintenance of inverter

Check Item	Check Content	Maintain content	Maintenance Interval
Inverter output status	Statistically maintain the status of electrical yield, and remotely monitor its abnormal status.	NA	Weekly
Inverter appearance	Check periodically and ensure that the heat sink is free from dust and blockage.	Clean periodically the heat sink.	Yearly
Inverter running status	a. Check that the inverter is not damaged or deformed. b. Check for normal sound emitted during inverter operation. c. Check and ensure that all inverter communications is running well.	If there is any abnormal phenomenon,replace the relevant parts.	Monthly
Inverter Electrical Connections	a. Check and ensure that AC, DC, and communication cables are securely connected; b. Check and ensure that PGND cables are securely connected; c. Check and ensure that cables are intact and free from aging;	If there is any abnormal phenomenon,replace the cable or re-connect it.	Semiannually

Fan Maintenance

When the external fan of the inverter can't work normally, the inverter may not cool effectively. It may affect the efficiency of the inverter or cause derating operation. Keep the fan clean and replace the damaged fan in time.

Step1 Shutdown the inverter.

Step2 Refer to electrical connection installation and disconnect the inverter in the opposite steps.

Step3 Refer to mechanical installation and remove the inverter in the opposite steps.

Step4 Screw down two security screws anticlockwise which on the inverter fan bracket .

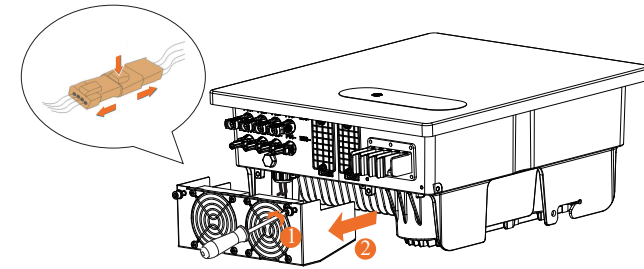

(Only take 25k modle as an example)

Step5 Use a soft brush to clean the fan. If you need to replace the fan, use a screwdriver to unscrew the fan bracket and remove the fan.



Step6 Install the new fan in the opposite steps, and then power on the system.

-----Ending

Inverter Uninstall

Inverter uninstall requires below procedure:

Step1: Disconnection all electric connections including these of communications cables, DC input cables, AC output cables and the PGND cables.

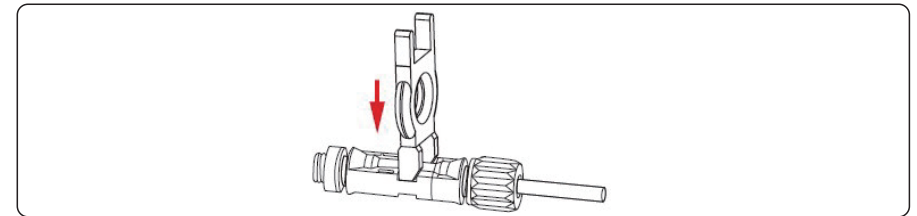

Note:

When uninstalling DC input connectors, insert removal wrench into the bayonet shown in Figure, press the wrench down, and take out the connector.

Step2: Remove the inverter from its rear panel.

Step3: Remove the rear panel.

WARNING	<p>Before uninstalling all electric connections, DC input connector, AC output cables and the PGND cables, please ensure that both the AC terminal and the DC terminal are powered off. And the DC switch is OFF to avert equipment damage or personal injury.</p>
----------------	--

9 Technical Specifications

MODEL	PV 5KTL-D3/G2	PV 6KTL-D3/G2	PV 8KTL-D3/G2	PV 10KTL-D3/G2
Input(PV)				
Max. PV power voltage (V)	1100V			
Rated input voltage (V)	620V			
Max. input current Imp(A)	15A/15A	15A/15A	15A/15A	15A/15A
Max. short-circuit current Isc(A)	20A/20A	20A/20A	20A/20A	20A/20A
Starting voltage/Min. operating voltage	180V/160V			
MPPT operating voltage range	160V-1000V			
MPPT voltage range @full load (V)	170V-850V	210V-850V	270V-850V	340V-850V
Max. numbers of input strings	2 (1/1)			
Numbers of MPPT input	2			
Maximum Feedback Current(A)	0A			
Output(Grid)				
Rated output power	5KW	6KW	8KW	10KW
Rated output apparent power	5KVA	6KVA	8KVA	10KVA
Max. apparent power	5.5KVA	6.6KVA	8.8KVA	11.2KVA
Max. active power	5.5KW	6.6KW	8.8KW	11.2KW
Max. output current	3*8.4A	3*10.1A	3*13.4A	3*17A
Rated output current	3*7.6/7.2/6.9A	3*9.1/8.7/8.3A	3*12.1/11.6/11.1A	3*15.2/14.5/13.9A
Inrush Current	40A	40A	40A	40A
Maximum Output Overcurrent Protection	40A	40A	40A	40A
Maximum Output Fault Current	60A	60A	60A	60A
Rated output voltage (V)	380V/400V/415V 3W+N+PE			
AC voltage range	260V-510V(Adjustable)			
Rated grid frequency	50Hz/60Hz			
Grid frequency range	45Hz-55Hz/55Hz-65Hz			
THDI	<3% Rated power			
Current DC off-sets	<0.5%In or 50mA			
Adjustable power factor range	>0.99@full load power (adjustable 0.8LG-0.8LD)			
Protection				
DC switch	Support			
Anti-islanding protection	Active Frequency Drift			
AC Overcurrent protection	Support			
AC short circuit protection	Support			
DC reverse connection	Support			
Surge Arrester	DC Type II/III; AC Type II/III (Optional)			
Insulation impedance detection	Support			
Leakage current protection	Support			
General				
Topology	Support			
Protection grade	IP66			
Power consumption at night	<1W			
Cooling type	5~15K(natural-cooling)/15~25K(air-cooling)			
Operating temperature range	-25°C-60°C(Maximum 45°C without derating)			
Operating relative humidity range	0~100%			
Max. operation altitude	4000m			
Noise emission	<30dB representative value (natural-cooling)			
Dimensions (W*H*D)	(398*460*190) mm			
Weight (kg)	16.8			
Display & Communication				
Display	LED/LCD(Optional)			
Communication	Bluetooth&WiFi,RS485/GPRS/4G(Optional)			
Protective Class	class I	class I	class I	class I
AC Overvoltage Category	Category III	Category III	Category III	Category III
DC Overvoltage Category	Category II	Category II	Category II	Category II
Inverter Topology	Non-isolated	Non-isolated	Non-isolated	Non-isolated
Grid Connection Standard	AS/NZS4777.2-2020	AS/NZS4777.2-2020	AS/NZS4777.2-2020	AS/NZS4777.2-2020

MODEL	PV 10KTL-D3/G2P	PV 12KTL-D3/G2	PV 15KTL-D3/G2
Input(PV)			
Max. PV power voltage (V)	1100V		
Rated input voltage (V)	620V		
Max. input current Imp(A)	15A/30A	15A/30A	15A/30A
Max. short-circuit current Isc(A)	20A/40A	20A/40A	20A/40A
Starting voltage/Min. operating voltage	180V/160V		
MPPT operating voltage range	160V-1000V		
MPPT voltage range @full load (V)	510V-850V	270V-850V	340V-850V
Max. numbers of input strings	3 (1/2)		
Numbers of MPPT input	2		
Maximum Feedback Current(A)	0A		
Output(Grid)			
Rated output power	10KW	12KW	15KW
Rated output apparent power	10KVA	12KVA	15KVA
Max. apparent power	11KVA	13.2KVA	16.7KVA
Max. active power	11KW	13.2KW	16.7KW
Max. output current	3*16.8A	3*20.2A	3*25.3A
Rated output current	3*15.2/14.5/13.9A	3*18.2/17.4/16.7A	3*22.7/21.7/20.8A
Inrush Current	40A	55A	55A
Maximum Output Overcurrent Protection	40A	55A	55A
Maximum Output Fault Current	60A	82.5A	82.5A
Rated output voltage (V)	380V/400V/415V 3W+N+PE		
AC voltage range	260V-510V(Adjustable)		
Rated grid frequency	50Hz/60Hz		
Grid frequency range	45Hz-55Hz/55Hz-65Hz		
THDI	<3% Rated power		
current DC off-sets	<0.5%In or 50mA		
Adjustable power factor range	>0.99@full load power (adjustable 0.8LG-0.8LD)		
Protection			
DC switch	Support		
Anti-islanding protection	Active Frequency Drift		
AC Overcurrent protection	Support		
AC short circuit protection	Support		
DC reverse connection	Support		
Surge Arrester	DC Type II/III; AC Type II/III (Optional)		
Insulation impedance detection	Support		
Leakage current protection	Support		
General			
Topology	Support		
Protection grade	IP66		
Power consumption at night	<1W		
Cooling type	5~15K(natural-cooling)/15~25K(air-cooling)		
Operating temperature range	-25°C-60°C(Maximum 45°C without derating)		
Operating relative humidity range	0~100%		
Max. operation altitude	4000m		
Noise emission	<30dB representative value (natural-cooling)		
Dimensions (W*H*D)	(398*460*190) mm		
Weight (kg)	18.7		
Display & Communication			
Display	LED/LCD(Optional)		
Communication	Bluetooth&WiFi,RS485/GPRS/4G(Optional)		
Protective Class	class I	class I	class I
AC Overvoltage Category	Category III	Category III	Category III
DC Overvoltage Category	Category II	Category II	Category II
Inverter Topology	Non-isolated	Non-isolated	Non-isolated
Grid Connection Standard	AS/NZS4777.2-2020	AS/NZS4777.2-2020	AS/NZS4777.2-2020

MODEL	PV 15KTL-D3/G2P	PV 17KTL-D3/G2	PV 20KTL-D3/G2
Input(PV)			
Max. PV power voltage (V)	1100V		
Rated input voltage (V)	620V		
Max. input current Imp(A)	30A/30A	30A/30A	30A/30A
Max. short-circuit current Isc(A)	40A/40A	40A/40A	40A/40A
Starting voltage/Min. operating voltage	180V/160V		
MPPT operating voltage range	160V-1000V		
MPPT voltage range @full load (V)	380V-850V	290V-850V	340V-850V
Max. numbers of input strings	4(2/2)		
Numbers of MPPT input	2		
Maximum Feedback Current(A)	0A		
Output(Grid)			
Rated output power	15KW	17KW	20KW
Rated output apparent power	15KVA	17KA	20KA
Max. apparent power	16.5KVA	18.7KVA	22KVA
Max. active power	16.5KW	18.7KW	22KW
Max. output current	3*25.3A	3*28.6A	3*33.7A
Rated output current	3*22.7/21.7/20.8A	3*25.8/24.6/23.6A	3*30.3/29/27.8A
Inrush Current	55A	98A	98A
Maximum Output Overcurrent Protection	55A	98A	98A
Maximum Output Fault Current	82.5A	147A	147A
Rated output voltage (V)	380V/400V/415V 3W+N+PE		
AC voltage range	260V-510V(Adjustable)		
Rated grid frequency	50Hz/60Hz		
Grid frequency range	45Hz-55Hz/55Hz-65Hz		
THDI	<3% Rated power		
current DC off-sets	<0.5%In or 50mA		
Adjustable power factor range	>0.99@full load power (adjustable 0.8LG-0.8LD)		
Protection			
DC switch	Support		
Anti-islanding protection	Active Frequency Drift		
AC Overcurrent protection	Support		
AC short circuit protection	Support		
DC reverse connection	Support		
Surge Arrester	DC Type II/III; AC Type II/III (Optional)		
Insulation impedance detection	Support		
Leakage current protection	Support		
General			
Topology	Support		
Protection grade	IP66		
Power consumption at night	<1W		
Cooling type	5~15K(natural-cooling)/15~25K(air-cooling)		
Operating temperature range	-25°C-60°C(Maximum 45°C without derating)		
Operating relative humidity range	0~100%		
Max. operation altitude	4000m		
Noise emission	<45 dB(air-cooling)		
Dimensions (W*H*D)	(398*460*190) mm		
Weight (kg)	20.1		
Display & Communication			
Display	LED/LCD(Optional)		
Communication	Bluetooth&WiFi,RS485/GPRS/4G(Optional)		
Protective Class	class I	class I	class I
AC Overvoltage Category	Category III	Category III	Category III
DC Overvoltage Category	Category II	Category II	Category II
Inverter Topology	Non-isolated	Non-isolated	Non-isolated
Grid Connection Standard	AS/NZS4777.2-2020	AS/NZS4777.2-2020	AS/NZS4777.2-2020

MODEL	PV 22KTL-D3/G2	PV 25KTL-D3/G2
Input(PV)		
Max. PV power voltage (V)	1100V	
Rated input voltage (V)	620V	
Max. input current Imp(A)	30A/30A	30A/30A
Max. short-circuit current Isc(A)	40A/40A	40A/40A
Starting voltage/Min. operating voltage	180V/160V	
MPPT operating voltage range	160V-1000V	
MPPT voltage range @full load (V)	380V-850V	430V-850V
Max. numbers of input strings	4(2/2)	
Numbers of MPPT input	2	
Maximum Feedback Current(A)	0A	
Output(Grid)		
Rated output power	22KW	25KW
Rated output apparent power	22KA	25KA
Max. apparent power	24.2KVA	27.5KVA
Max. active power	24.2KW	27.5KW
Max. output current	3*37A	3*39.8A
Rated output current	3*33.3/31.9/30.6A	3*37.9/36.2/34.7A
Inrush Current	98A	98A
Maximum Output Overcurrent Protection	98A	98A
Maximum Output Fault Current	147A	147A
Rated output voltage (V)	380V/400V/415V 3W+N+PE	
AC voltage range	260V-510V(Adjustable)	
Rated grid frequency	50Hz/60Hz	
Grid frequency range	45Hz-55Hz/55Hz-65Hz	
THDI	<3% Rated power	
current DC off-sets	<0.5%In or 50mA	
Adjustable power factor range	>0.99@full load power (adjustable 0.8LG-0.8LD)	
Protection		
DC switch	Support	
Anti-islanding protection	Active Frequency Drift	
AC Overcurrent protection	Support	
AC short circuit protection	Support	
DC reverse connection	Support	
Surge Arrester	DC Type II/III; AC Type II/III (Optional)	
Insulation impedance detection	Support	
Leakage current protection	Support	
General		
Topology	Support	
Protection grade	IP66	
Power consumption at night	<1W	
Cooling type	5~15K(natural-cooling)/15~25K(air-cooling)	
Operating temperature range	-25°C-60°C(Maximum 45°C without derating)	
Operating relative humidity range	0~100%	
Max. operation altitude	4000m	
Noise emission	<45 dB(air-cooling)	
Dimensions (W*H*D)	(398*460*190) mm	
Weight (kg)	20.3	
Display & Communication		
Display	LED/LCD(Optional)	
Communication	Bluetooth&WiFi,RS485/GPRS/4G(Optional)	
Protective Class	class I	class I
AC Overvoltage Category	Category III	Category III
DC Overvoltage Category	Category II	Category II
Inverter Topology	Non-isolated	Non-isolated
Grid Connection Standard	AS/NZS4777.2-2020	AS/NZS4777.2-2020