

PrimeVOLT

USER MANUAL

Single Phase Grid-tied PV String Inverter

PV 7KTL-D1P
PV 8KTL-D1P
PV 10KTL-D1P

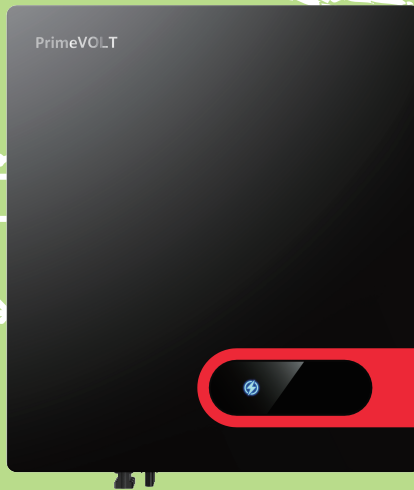

History

VERSION	ISSUED	COMMENTS
1.0	01-Feb.-23	First release

Preface

About This Manual

This manual describes the installation, connection, the use of APP, commissioning and maintenance etc. of the inverter. Please first read the manual and related documents carefully before using the product and store it in a place where installation, operation and maintenance personnel can reach it at any time. The illustrations in this user manual are for reference only. This user manual is subject to change without prior notice. (Specific please in kind prevail.)

Target group







Inverters must be installed by professional electrical engineers who have obtained relevant qualifications.

Scope

- PV 7KTL-D1P
- PV 8KTL-D1P
- PV 10KTL-D1P

Symbol Conventions

Safety symbols used in this manual, which highlight potential hazards and important safety information, are listed as follows:

 DANGER	Indicates an imminently hazardous situation which, if not correctly followed, will result in serious injury or death.
 WARNING	Indicates a potentially hazardous situation which, if not correctly followed, will result in serious injury or death.
 CAUTION	Indicates a potentially hazardous situation which, if not correctly followed, could result in moderate or minor injury
 NOTICE	Indicates a potentially hazardous situation which, if not correctly followed, could result in equipment failure to run, or property damage.
 NOTE	Call attention to important information, best practices and tips: supplement additional safety instructions for your better use of the ESS inverter to reduce the waste of you resource
 REFER	Refer to documentation (Remind operators to refer to the documentation shipped with the inverter).

Note: This user manual may be updated periodically, and the actual product purchased shall prevail. User can obtain the latest manual from distributors.

Contents









Preface	II
About This Manual	II
Target group	II
Scope	II
Symbol Conventions	II
1 Safety	01
1.1 Symbol used	01
1.2 Safety Precautions	02
2 Product Introduction	04
2.1 Functional Models	04
2.2 Network Application	04
2.3 Outline and Dimensions	05
2.4 Working Process	07
2.5 Working Modes	08
3 Unpacking and Storage	09
3.1 Unpacking and Check	09
3.2 Storage	10
3.3 Identify Inverter	10
4 Installation	11
4.1 Moving the inverter	11
4.2 Installation Requirements	12
4.3 Installing a Rear Panel	16
4.4 Installing the Inverter	18

5 Electrical Connections	19
5.1 Connecting Protection Ground (PGND) Cables	19
5.2 Connecting AC Output Cables	21
5.3 Connecting the PV Strings	24
5.4 Connecting Communication Cables	28
5.5 Power limit (optional)	32
5.6 GPRS/WIFI/LAN Module Connection	34
6 Startup/Shutdown Procedure	35
6.1 Check before startup/shutdown Procedure	35
6.2 Startup Procedure	35
6.3 Shutdown Procedure	36
7 User Interface	37
7.1 LED	38
7.2 LCD automatic-page-turning display	40
8 Maintenance	41
8.1 Routine Maintenance	41
8.2 Inverter Troubleshooting	42
8.3 Removing the Inverter	44
Appendix	

1 Safety

Before using the inverter, please read all instructions and cautionary markings on the unit and in the manual. Put the instructions to a place where you can take them easily. Our inverter strictly conforms to related safety rules in design and test. And follow the local laws and regulations during installation, operation and maintenance. Incorrect operation may cause injury or death to the operator or a third party, and damage to the inverter and other properties belonging to the operator or a third party.

1.1 Symbol used

Safety Symbol	Description
	Danger of high voltage and electric shock! Only qualified personnel may perform work on the inverter.
	Residual voltage exists after the inverter is powered off. It takes 5 minutes for system to discharge to a safe voltage.
	Danger of hot surface
	Do not disconnect under load! (Fire danger)
	Environmental Protection Use Period
	Refer to the operating instructions
	Product should not be disposed as household waste.
	Grounding terminal
	The PV inverter is compliant with TUV.

1.2 Safety Precautions

1.2.1 Personnel Safety

- a. The PV inverter must be installed, electronically connected, operated and maintained through specially trained technician;
- b. The qualified technician must be familiar with the safety regulations of electrical system, working process of PV power generation system, and standards of local power grid;
- c. The technician must read through this User Manual carefully and master it before any operation.

1.2.2 PV Inverter Protection

	<p>NOTICE As soon as receiving the PV inverter, please check if it is damaged during its transportation. If yes, please contact your dealer immediately.</p>
-----------------------------------------------------------------------------------	---------------------------------------------------------------------------------------------------------------------------------------------------------------------

- a. Do not tamper with any warning signs on the inverter the inverter housing as they contain important information for safe operation.
- b. Do not remove or damage the nameplate on the inverter’s enclosure because it contains important product information.

1.2.3 Installation Safety

	<p>NOTICE Please read the User Manual carefully before installing the PV inverter; warranty or liability will be exempted from the company if damage is caused by installation faults.</p>
-----------------------------------------------------------------------------------	---------------------------------------------------------------------------------------------------------------------------------------------------------------------------------------------------



- a. Ensure there is no electrical connections around ports of the PV inverter before installation;
- b. Adequate ventilation must be provided for inverter installation location. Mount the inverter in vertical direction, and ensure that no object is put on the heat sink affecting the cooling. (For details, refer to Chapter 4 Installation)
- c. This inverter must be installed by the "Australia local agent professional person who authorized by manufacturer". This professional person should familiar with Australia relevant electrical regulations to ensure all installation comply with Electromechanical regulations.

1.2.4 Electrical Connections

	<p>DANGER Before installing the inverter, check all electrical ports to ensure no damage and no short circuit. Otherwise personal casualty and/or fire will occur.</p>
-------------------------------------------------------------------------------------	-------------------------------------------------------------------------------------------------------------------------------------------------------------------------------

- a. Input terminals of the PV inverter apply only to input terminals of PV String; do not connect any other DC sources to the input terminals.
- b. Before connecting PV modules, ensure the voltage is within the safe range; when exposed to any sunlight, PV modules can generate high voltage.
- c. All electrical connections must meet the electrical standards of the country or region.
- d. Cables used in electrical connections must be well fixed, under good insulation, and with appropriate specification.

1.2.5 Operating and Commissioning

 <p>DANGER</p>	<p>While the inverter operating, high voltage can lead to an electric shock hazard, and even cause personal casualties. Therefore, operate the PV inverter strictly according to the safety precautions in the user manual.</p>
 <p>WARNING</p>	<p>When the photovoltaic array is exposed to light, it supplies DC WARNING voltage to the PCE.</p>

- a. Before getting the permission from electrical power authority in the country/region, the grid-tied PV inverter cannot start power generation.
- b. Follow the procedures of commissioning described in this user manual when commissioning the PV inverter.
- c. Do not touch any other parts' surface except the DC switch when the PV inverter is operating; its partial parts will be extremely hot and can cause burns.

1.2.6 Maintenance

 <p>DANGER</p>	<p>Power OFF all electrical terminals before the inverter maintenance; strictly comply with the safety precautions in this document when operating the inverter.</p>
--------------------------------------------------------------------------------------------------	----------------------------------------------------------------------------------------------------------------------------------------------------------------------

- a. For personal safety, wear appropriate personal protective equipment such as insulated gloves and protective shoes for the inverter maintenance.
- b. Place temporary warning signs or erect fences to prevent unauthorized access to the maintenance site.
- c. Follow the procedures of maintenance stipulated in the manual strictly.
- d. Check the relevant safety and performance of the inverter; rectify any faults that may compromise the inverter security performance before restarting the inverter.

1.2.7 Additional Information

 <p>NOTICE</p>	<p>To avoid any other unforeseeable risk, contact your dealer immediately, if there is any issue found during operation.</p>
---------------------------------------------------------------------------------------------------	------------------------------------------------------------------------------------------------------------------------------



2 Product Introduction

This chapter introduces the inverter and describes its functional model, network application, appearance, dimensions and working process etc.

2.1 Functional Models

2.1.1 Function

This series is a single-phase grid-tied PV string inverter (transformer less) that converts the DC power generated by PV strings into AC power and feeds the power into power grid.

 WARNING	The inverter is transformer less. Add an isolation transformer before grounding the positive negative terminal of PV modules (like Thin Film module) for operation.
 WARNING	Do not connect PV modules in parallel to several PV inverters for operation.

2.1.2 Model Definition

Figure2.1 shows a model number of the inverter, using PV 8KTL-D1P as an example.

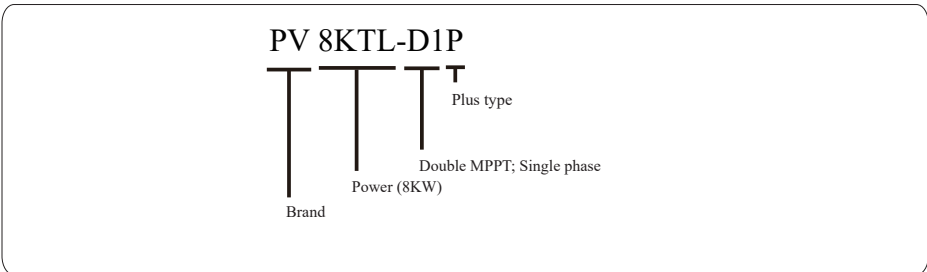

Figure2.1 Model number descriptions

2.2 Network Application

2.2.1 Grid-tied PV Power Systems

The series applies to grid-tied PV power systems for outdoor power stations. Typically, a grid-tied PV power system consists of PV modules, grid-tied inverters, AC distribution units, and low-voltage power grid, as shown in Figure 2.2.

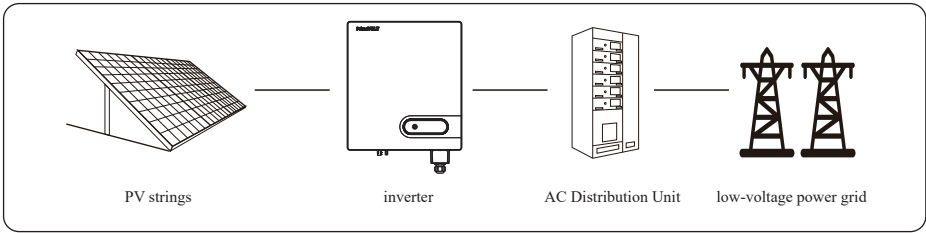

Figure2.2 a low-voltage grid-tied PV power system

Inverters have been tested as per AS/NZS 4777.2:2020 for three phase combinations.

2.3 Outline and Dimensions

2.3.1 Outline

Figures2.3 to 2.7 show the outline of the inverters as follows:

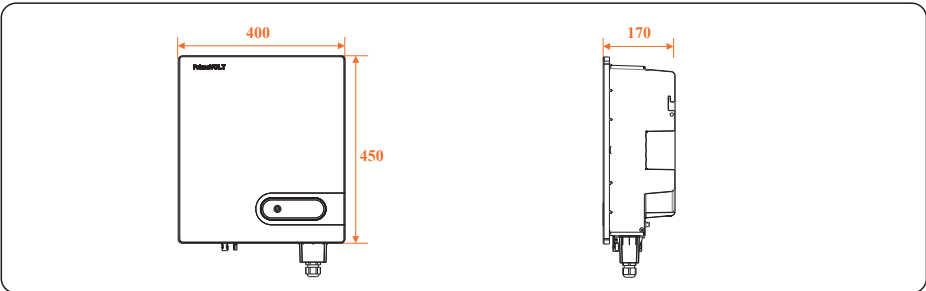

Figure2.3 The outline and dimensions of the Inverter (unit: mm)

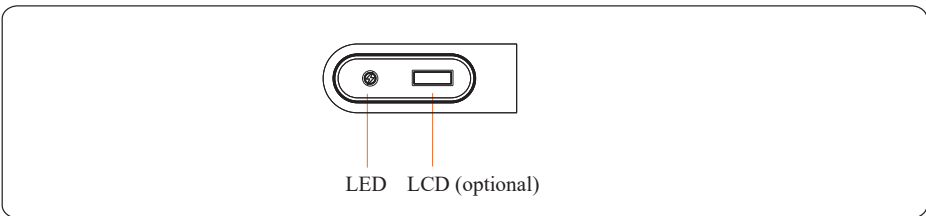

Figure2.4 The front view and amplification effect of LED indicator area

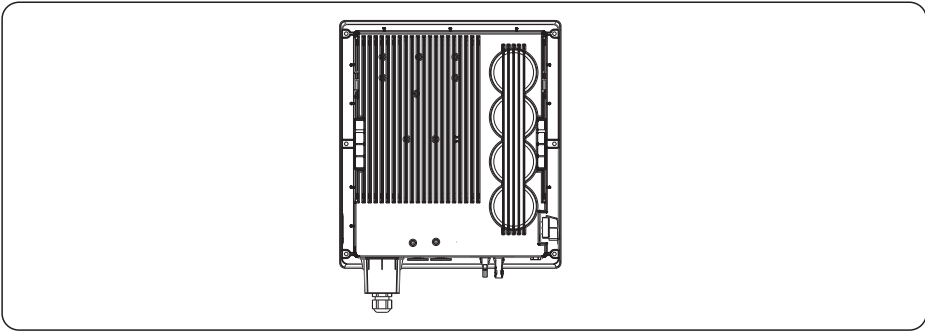

Figure2.5 The rear view of this series inverter

PV 7KTL-D1P

- 1. DC isolation switch
- 2. Vent valve
- 3. PV input connectors (2 Strings)
- 4. COM2 (RS485/meter/CT/DI)
- 5. COM1 (WIFI/GPRS/Ethernet/RS485)
- 6. AC output connector
- 7. External protection ground interface

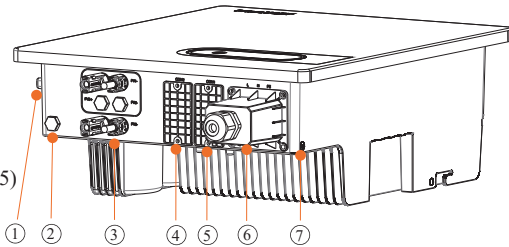

Figure2.6 The bottom view of this series inverter

PV 8KTL-D1P/PV 10KTL-D1P

- 1. DC isolation switch
- 2. Vent valve
- 3. PV input connectors (3 Strings)
- 4. COM2 (RS485/meter/CT/DI)
- 5. COM1 (WIFI/GPRS/Ethernet/RS485)
- 6. AC output connector
- 7. External protection ground interface

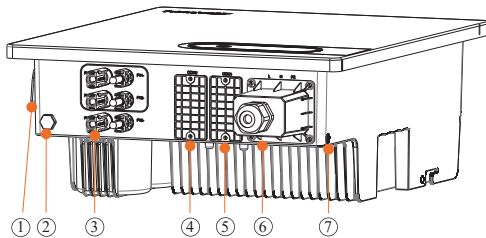

Figure2.7 The bottom view of this series inverter

2.4 Working Process

2.4.1 Basic principle Description

7-10K receive inputs from PV strings through DC switch and surge protection in order: there are 2 groups of PV strings input terminals on DC input terminal of 7K there are 3 groups of PV strings input terminals on 8-10K with the 1st and 2nd routes terminals merging into one independent MPPT. Then the inputs are grouped into two MPPT routes inside the inverter to track the maximum power point of the PV strings. These two MPPT power is then converted into DC Bus which is then converted to AC power through an inverter circuit. Finally the converted AC power is fed to the Power grid through the inverter. Surge protection and EMI filter are supported on both the DC and AC sides to reduce electromagnetic interference.

2.4.2 Circuit Diagrams

Figure 2.9 shows the circuit diagram for the 7K PV Inverter:

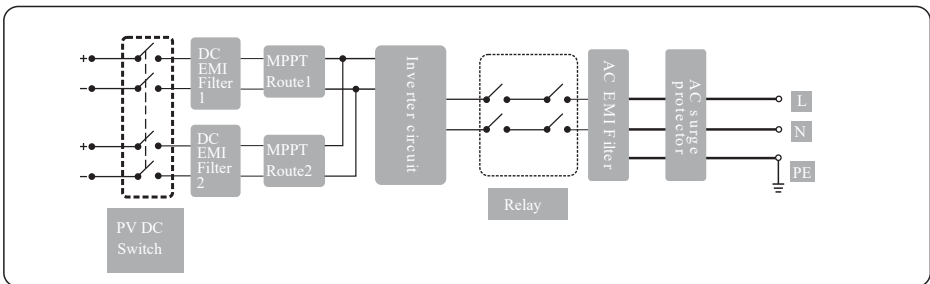

Figure 2.9 circuit diagram

Figure 2.10 shows the circuit diagram for the 8-10K PV Inverter:

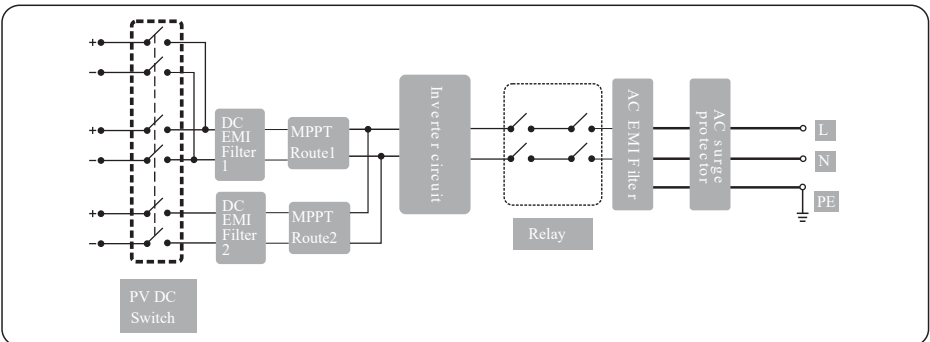

Figure 2.10 circuit diagram

2.5 Working Modes

Three working modes of the inverter are shown as follows: standby, operating and shut down.

Table 2.1 shows the conditions for the inverter to switch between working modes.

Modes	Description
Standby	The PV inverter enters the standby mode when > the input voltage of PV Strings can enable auxiliary power supply to run but cannot meet the inverter operation requirements. > the input voltage of PV Strings can meet the inverter to-start requirements. but cannot meet its minimum power requirements.
Operating	When the PV inverter is grid-tied and generates electricity, it > tracks the maximum power point to maximize the PV String output. > converts DC power from PV strings into AC power and feeds the power to the power grid. The PV inverter will enter to the shutdown mode if detecting a fault or a shutdown command.
Shutdown	The PV inverter switches from standby or operating mode to shutdown mode if detecting a fault or a shutdown command. The inverter switches from shutdown mode to standby mode if receiving a Startup command or detecting that a fault is rectified.

Table2.1 Working modes description

 <p>NOTICE</p>	<p>Instructions that if the equipment is used in a manner not specified by the manufacturer, the protection provided by the equipment may be impaired.</p>
---------------------------------------------------------------------------------------------------	------------------------------------------------------------------------------------------------------------------------------------------------------------

3 Unpacking and Storage

3.1 Unpacking and Check

- a. When receiving the inverter, check that the packing materials are intact.
- b. After unpacking, check that the contents are complete, intact, and consistent with your order list.
- c. Examine the PV inverter and its fittings for damage such as scraps and cracks.

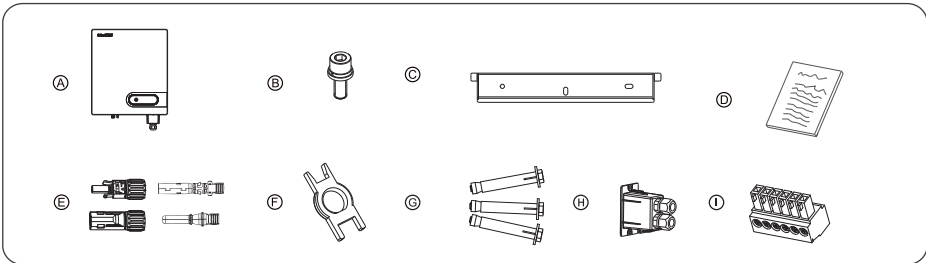

Items	Deliverables
A	The inverter
B	M6 Screw
C	Rear panel
D	File package
E	DC terminal connector group
F	Removal tool for DC connector
G	Expansion screws (reserved for tightening the rear panel)
H	RS485 cover
I	6-Pin terminal

Figures 3.1 The contents: The inverter and its fittings

 NOTICE	If any damage mentioned above is found, contact the dealer immediately.
---------------------------------------------------------------------------------------------------	-------------------------------------------------------------------------

3.2 Storage

This chapter describes the storage requirements for the inverter.

The following storage instructions apply if the PV inverter will not be deployed immediately:

- > Do not unpack the inverter (put desiccant in the original box if the PV inverter is unpacked).
- > Store the PV inverter at a temperature range of -25°C to +60°C and with the relative humidity of 0% to 100% (no condensing).
- > The PV inverter should be stored in a clean and dry place and be protected from dust and water vapor corrosion.
- > The inverter packing should be upright.
- > Conduct periodic inspection during storage. Replace the packing materials immediately if any rodent bites are found.
- > Ensure that qualified personnel inspect and test the inverter before use if it has been stored for a long time.

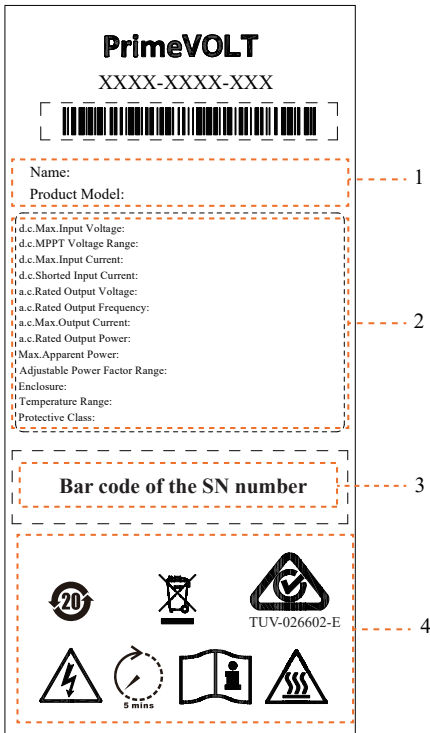

3.3 Identify Inverter

Inverter body label. The following is only for reference, specific please in kind prevail!



Number	Description
1	Product name and model
2	Product technical parameters
3	SN Barcode
4	Approve and Safety identification

4 Installation

 DANGER	Do not install the inverter on flammable building materials or in an area that stores flammable or explosive materials.
 CAUTION	Do not install the inverter in a place where personnel are likely to come into contact with its enclosure and heat sinks to avoid electrical shock/burn.

Inverters have been tested as per AS/NZS 4777.2:2020 for three phase combinations.

4.1 Moving the inverter

After checking the outer packing, move the PV inverter to the designated installation position horizontally. Hold the handles on both sides of the inverter, as shown in Figure 4.1.

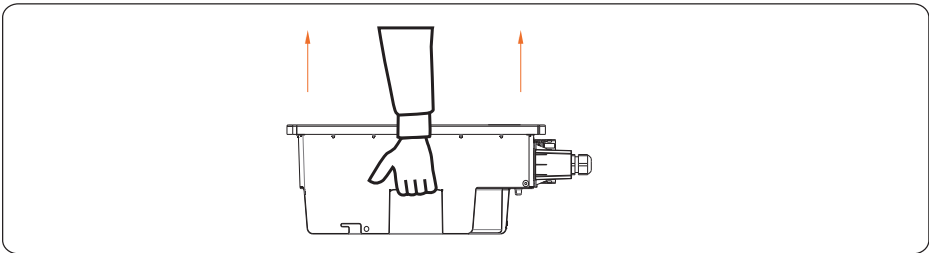



Figure 4.1 Moving the inverter

 CAUTION	<ul style="list-style-type: none"> > Do not place the PV inverter with its wiring terminals contacting the floor because the power ports and signal ports at the bottom of the device are not designed to support the weight of the inverter. > When placing the inverter on the floor horizontally, put foam or paper under to protect its enclosure.
---------------------------------------------------------------------------------------------	--------------------------------------------------------------------------------------------------------------------------------------------------------------------------------------------------------------------------------------------------------------------------------------------------------------------------------------------------------------------------------------

4.2 Installation Requirements

Applies to wall-mounting installation, as described below in detail.

4.2.1 Determining the installation Position

• Basic Requirements

- The inverter is protected to IP65 and can be installed indoors or outdoors.
- The installation method and position must be appropriate for the weight and dimensions of the inverter.
- Do not install the inverter in a place where personnel are likely to come into contact with its enclosure and heat sinks because these parts are extremely hot during operation.
- Do not install the inverter in an area that stores flammable or explosive materials.

• Installation Environment Requirements

- The ambient temperature must be below 50°C which ensures the inverter's optimal operation and extends its service life.
- The inverter must be installed in a well-ventilated environment to ensure good heat dissipation.
- The inverter must be free from direct exposure to sunlight, rain, and snow to extend its service life. It is recommended that the inverter be installed in a sheltered place. If no shelter is available, build an awning, as shown in Figure 4.2.

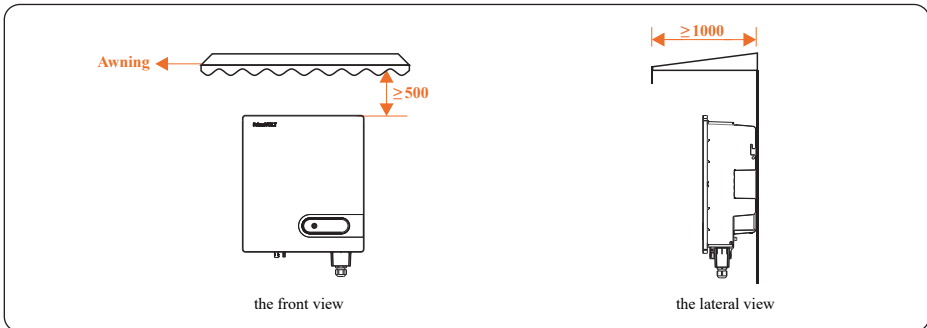

Figure4.2 Installation environment with awning (unit: mm)

• **Carrier Requirements**

- a. The carrier where the inverter is installed must be fire-proof. Do not install the inverter on flammable building materials.
- b. The wall must be solid enough to bear the weight of the inverter.
- c. Do not install the inverter on a wall made of gypsum boards or similar materials with weak sound insulation to avoid noise disturbance in a residential area.

• **Installation Space Requirements**

- a. It is recommended that the inverter is installed at eye level to facilitate operation and maintenance.
- b. Reserve enough clearance around the inverter to ensure sufficient space for installation and heat dissipation, as shown in Figure 4.3.

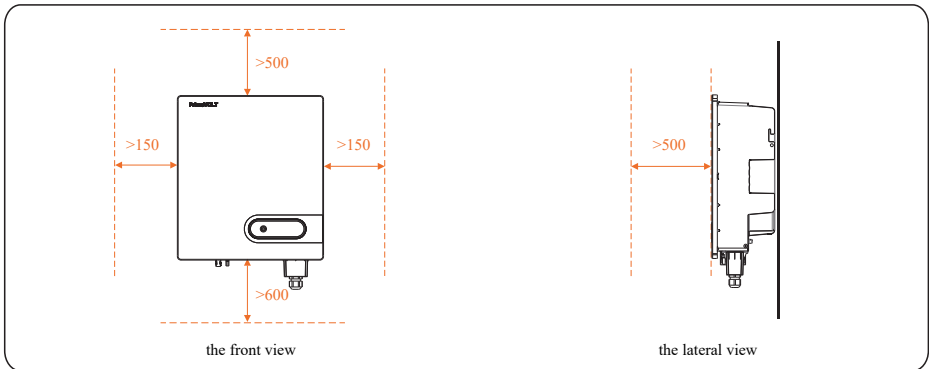

Figure4.3 Installation Space Requirements (unit: mm)

- c. When installing multiple inverter, install them along the same line (as shown in Figure 4.4) if sufficient space is available, and install them in triangle mode (as shown in Figure 4.5) or in stacked mode (as shown in Figure 4.6) if no sufficient space is available. The installation modes ensure sufficient space for installation and heat dissipation.

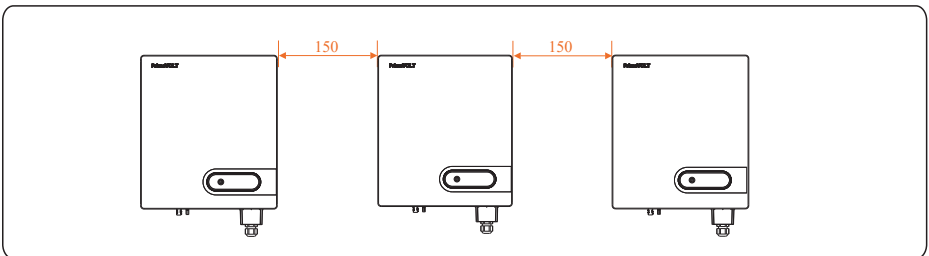

Figure4.4 Installation along the same line (unit: mm)

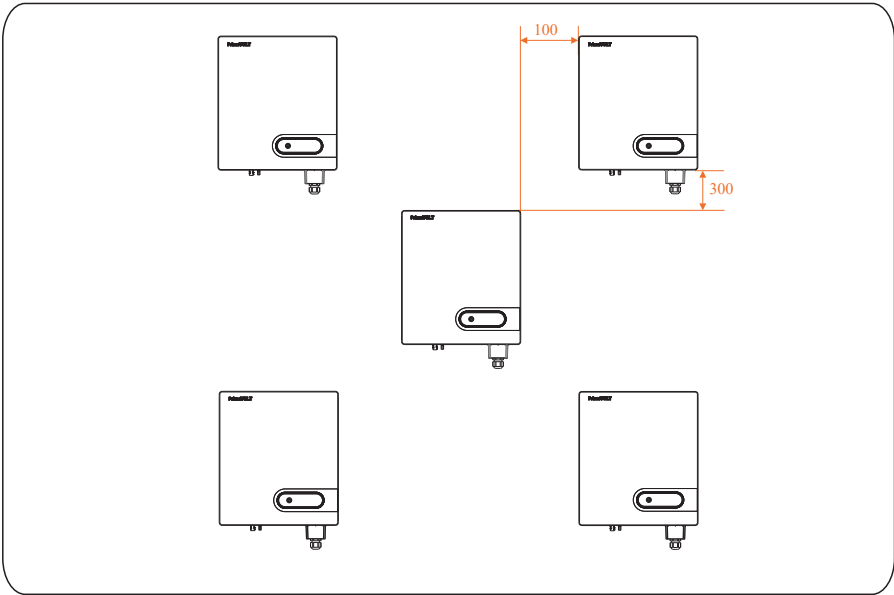

Figure4.5 Installation in triangle mode (unit: mm)

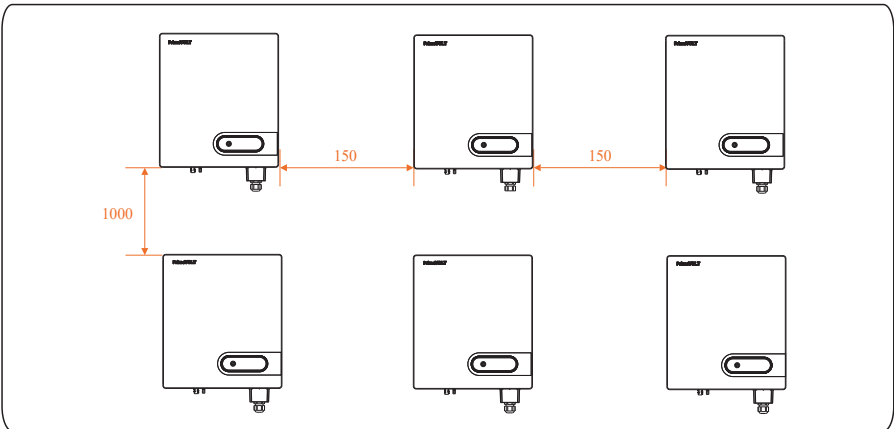

Figure4.6 Installation in stacked mode (unit: mm)



NOTICE

The clearance between multiple inverters must be increased to ensure proper heat dissipation when they are installed in a hot area.

4.2.2 Installation Mode Requirements

Install the inverter upright or at a maximum back tilt of 15 degrees to facilitate heat dissipation. Below are some correct/wrong installation modes, as shown in Figures 4.8 & 4.9.

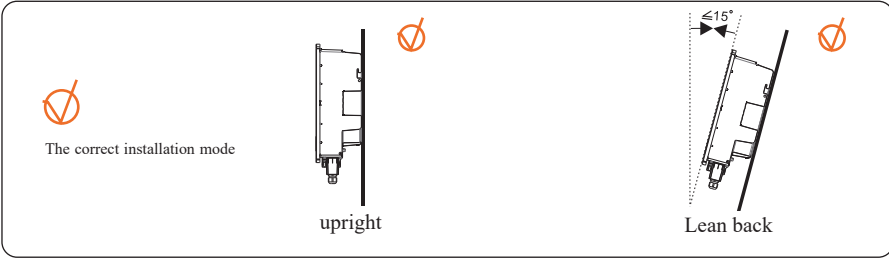

Figures4.7 The correct installation mode

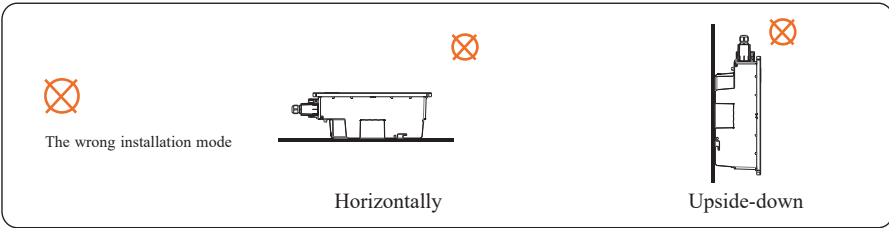



Figure4.8 The wrong installation modes

 <p>NOTICE</p>	<p>The wrong installation will lead to failure of the inverter operation.</p>
---------------------------------------------------------------------------------------------------	-------------------------------------------------------------------------------

4.3 Installing a Rear Panel

Before installing the inverter, secure the shipped rear panel to a wall.

Step 1 Move out the rear panel from the packing case.

Step 2 Determine the positions for drilling holes (as shown in Figure 4.9) using the rear panel.

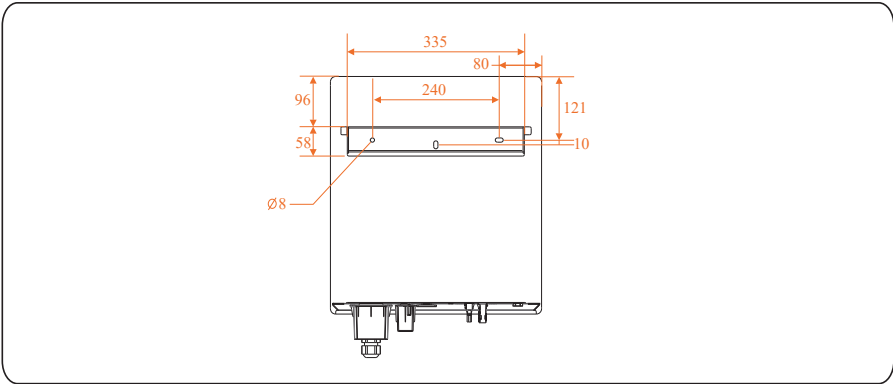

Figure 4.9 Determine the positions for drilling holes (unit : mm)

Step 3 Level the hole positions using a level, and mark the hole positions using a marker (as shown in Figure 4.10).

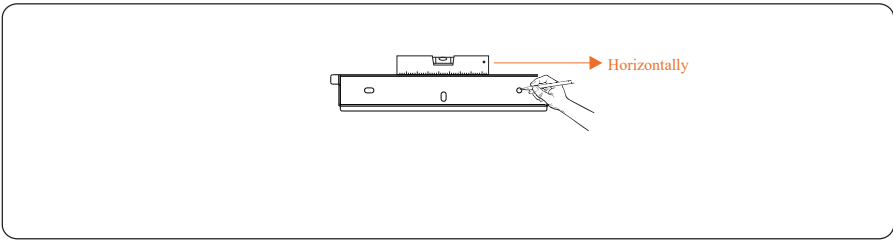

Figure 4.10 mark the hole positions using a marker

Step 4 Drill holes using a hammer drill and install expansion bolts, as shown in Figure 4.11.



DANGER

Before drilling the hole on the wall, ensure no damage on the electric wire and/or water pipe inside the wall.

- a. Drill a hole in a marked position to a depth of 60-65 mm using a hammer drill with a Φ 10 mm bit.
- b. Partially tighten an expansion bolt, vertically insert it into the hole, and knock the expansion bolt completely into the hole using a rubber mallet.

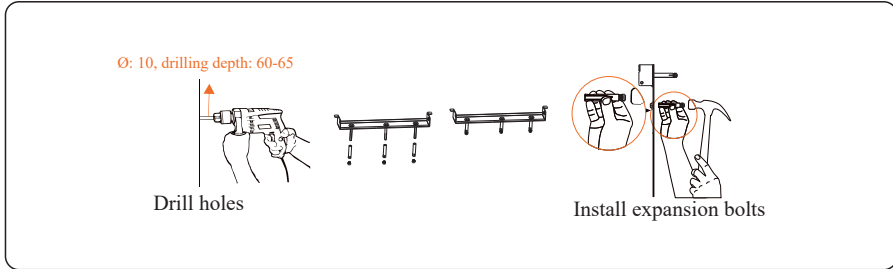

Figure 4.11 Punch holes and install expansion (unit: mm)

- Step 5** Align the rear panel with the holes, insert expansion bolts into the holes through the rear panel, and tighten the expansion bolts to a torque of 2.5 N·m using a torque wrench, as shown in Figure 4.12.

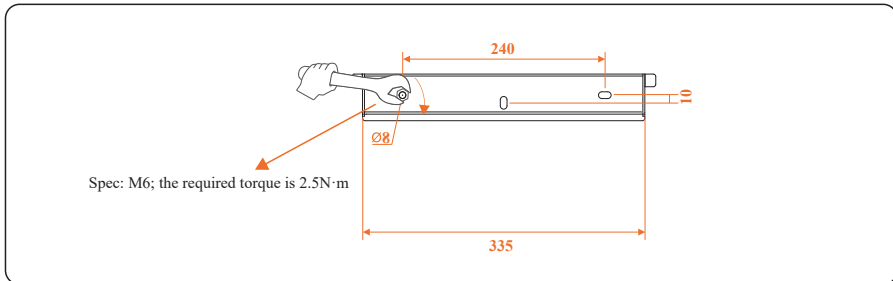

Figure 4.12 Installing the rear panel (unit: mm)

4.4 Installing the PV Inverter

Follow below procedures:

- Step 1** The installer to hold the handle at both sides of the inverter and then lift and stand the inverter.
- Step 2** Mount the inverter on the rear panel and keep them aligned with each other, as shown in Figure 4.13.
- Step 3** Tighten the two hexagon screws at the both sides of the inverter to a torque of $2\text{N}\cdot\text{m}$ respectively as shown in Figure 4.14.

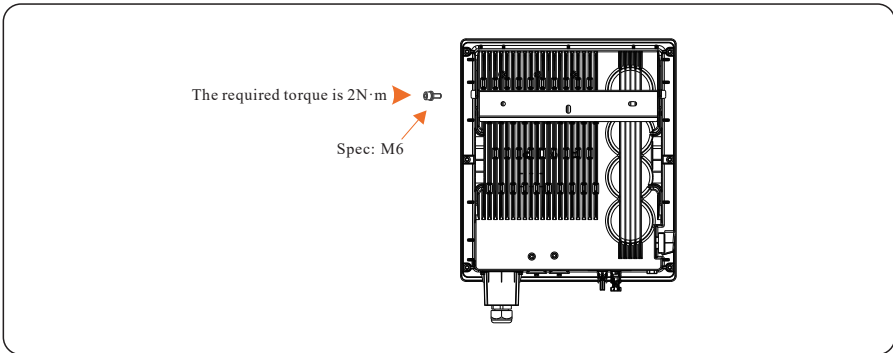



Figure 4.13 Securing the inverter

5 Electrical Connections

 <p>DANGER</p>	<p>Before performing any electrical connections, ensure that both DC and AC Switches are OFF. Otherwise, fatal injury can occur due to the high voltage.</p>
--------------------------------------------------------------------------------------------------------	--------------------------------------------------------------------------------------------------------------------------------------------------------------

5.1 Grounding

5.1.1 Preparation

The ground cable and OT terminals have been prepared.

- a. Ground cable: Outdoor copper-core cables with a cross sectional area of 10 mm² or more are recommended.
- b. Specification of screw: M4; the required torque is 1.2N·m.

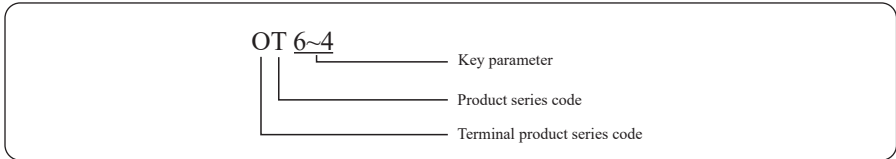

 <p>NOTE</p>	<p>Good grounding for the inverter helps resist the impact of surge voltage and improve the EMI performance. Connect the PGND cable before connecting the AC power cables, DC power cables, and communication cables.</p>
-----------------------------------------------------------------------------------------------	---------------------------------------------------------------------------------------------------------------------------------------------------------------------------------------------------------------------------

 <p>NOTE</p>	<p>It is recommended that the ground cable be connected to a nearby ground position. For a system with multiple inverters connected in parallel, connect the ground points of all inverters to ensure equipotential connections.</p>
-------------------------------------------------------------------------------------------------	--------------------------------------------------------------------------------------------------------------------------------------------------------------------------------------------------------------------------------------

5.1.2 Wiring Procedures

Step 1 Remove an appropriate length of the insulation layer from the PGND cable using a wire Stripper; the length is a little bit longer than that of OT terminal's crimping end by 2mm~3mm, as shown in Figure 5.1.

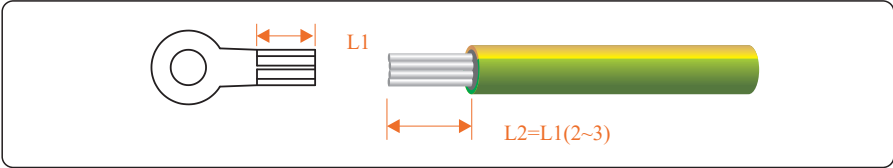

Figure 5.1 Stripped length (unit: mm)

Step 2 Insert the exposed core wires into the crimping areas of the OT terminal and crimp them using hydraulic pliers, as shown in Figure 5.2.

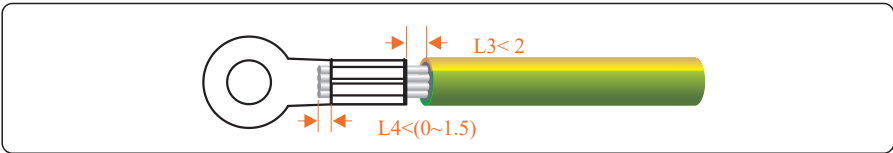

Figure 5.2 Crimping a cable (unit: mm)

Step 3 Remove the ground screws from the ground points, as shown in Figure 5.3.

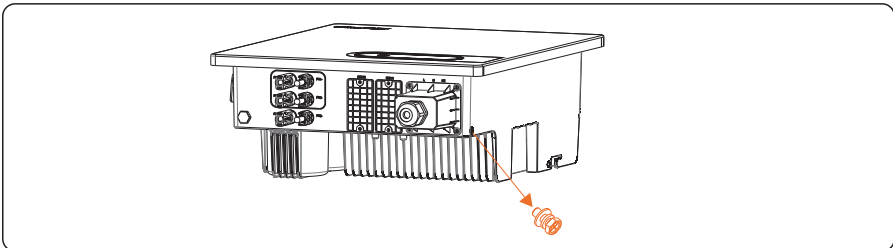

Figure 5.3 Remove the ground screws

Step 4 Secure the PGND cable (done by step1&2) using the ground screw and tighten the screw to a torque of 1.2 N·m using a socket wrench, as shown in Figure 5.4.

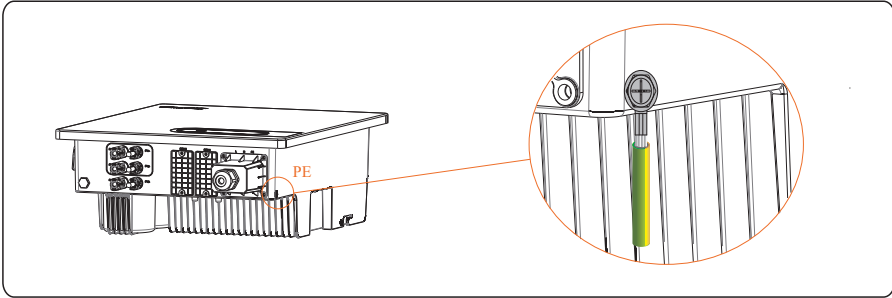

Figure 5.4 Secure the PGND cable

5.2 AC Connection

5.2.1 Preparation

The AC power cable and AC terminals have been prepared.

a. AC power cable: Outdoor copper-core cables are recommended. Table 5.1 describes the specifications.

Cable	Cable type	Cross-sectional Area (mm ²)		Cable Outer Diameter (mm)
		Range	Recommended Value	Range
AC cable	multi-core outdoor cable	8~14	10	14~20



Table 5.1 AC output cable specifications

b. The recommended specifications of circuit breaker are shown in the table below.

Inverter Model	Recommended Value
7K	50A
8K	50A
10K	60A

Table 5.2 Circuit breaker specifications

The RCD used on the main solar supply circuit should be Type A 100mA. This and all associated wiring must be installed in accordance with AS /NZS 4777.1

 <p>WARNING</p>	<p>An independent circuit breaker must be installed on the AC side of each inverter to ensure that the inverter can be safely disconnected from the power grid.</p>
 <p>WARNING</p>	<p>Do not connect loads between the AC output terminals of the inverter and circuit breaker.</p>

5.2.2 Procedure of Connecting AC Cables

 <p>NOTICE</p>	<p>For your operation and safety sake, please prepare multi-stranded wire, crimping terminals and a proper crimping tool before AC Wiring.</p>
-------------------------------------------------------------------------------------------------	------------------------------------------------------------------------------------------------------------------------------------------------

Step 1 Remove an appropriate length of the jacket and insulation layer from the AC output cable.

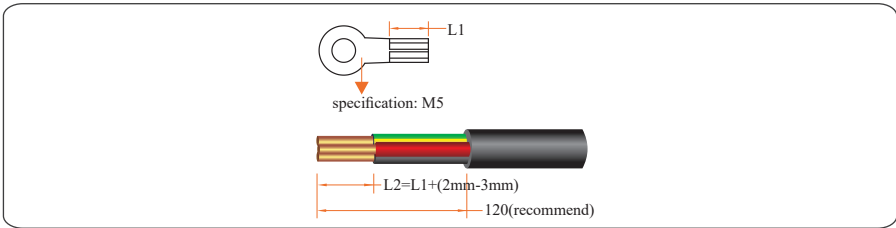

Figure 5.5 Stripped length (unit: mm)

Step 2 Insert the exposed core wires into the crimp area of the OT terminal and crimp them using hydraulic pliers. Wrap the wire crimp area with heat shrink tubing or PVC insulation tape.

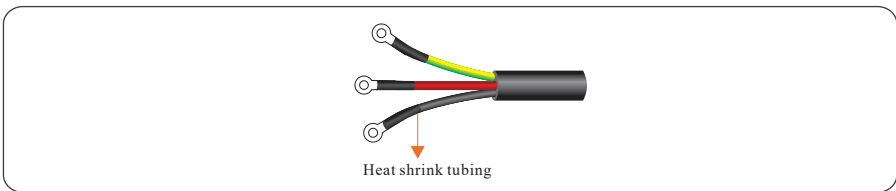

Figure 5.6 Crimping OT terminals

Step 3 Insert the processed AC output cables through waterproof terminals with reserved wire length for electrical connecting.

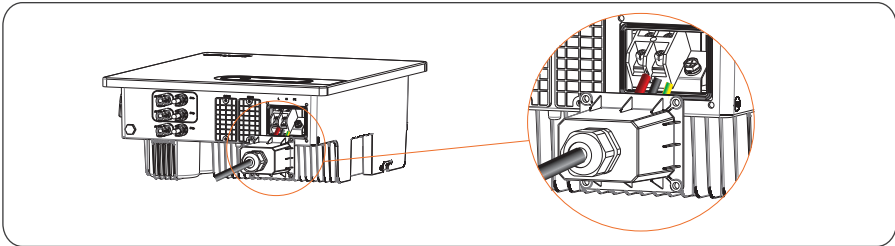

Figure 5.7 Connecting AC cable

Step 4 Rout AC output cables to L, N and PE on the AC terminal block respectively, and tighten them using screw driver to a torque of $1.5\text{N}\cdot\text{m}$.

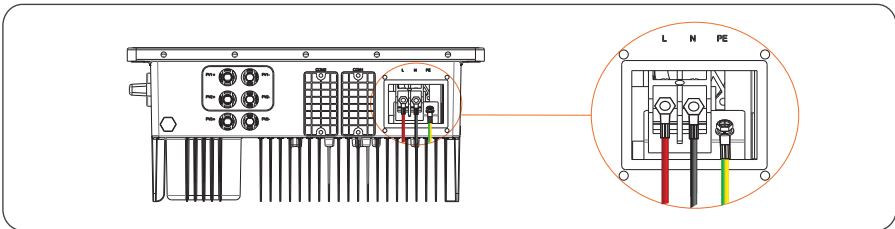

Figure 5.8 Connecting AC cable

Step 5 Aligning with the hole position on the AC terminal cover, use a screw driver to tighten screws to a torque of $1.2\text{N}\cdot\text{m}$.

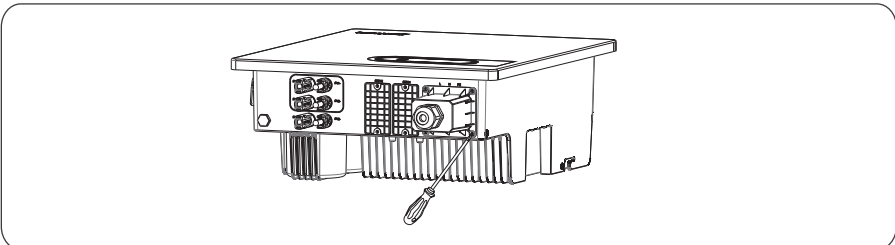



Figure 5.9 Connecting AC Connector

Step 6 Use a torque wrench to tighten the locking cap on the AC cable to a torque of $5\text{N}\cdot\text{m}$.

5.3 PV Connection

	DANGER	PV Strings connection needs below prerequisites; otherwise, an electrical shock can occur.
<p>PV modules generate electric energy when exposed to sunlight and can create an electrical shock hazard. Therefore, when connecting the PV modules, shield them with opaque cloth.</p>		
<p>Before connecting DC input power cables, ensure that the voltage on the DC side is within the safe range and that the DC SWITCH on the inverter is OFF. Otherwise, high voltage may result in electric shock.</p>		
<p>When the inverter is grid-tied, it is not allowed to maintain DC input power cables, such as connect or disconnect a string or a module in a string. Only after the inverter enters in shutdown mode, it is allowable for preceding DC input power cables maintenance.</p>		

	WARNING	Grounding the PV Strings needs below prerequisites; otherwise, a fire can occur.
<p>PV modules connected in series in each PV string must be of the same specifications.</p>		
<p>The maximum open-circuit voltage of each PV string must be always lower than or equal to its permitted range.</p>		
<p>The maximum short circuit current of each PV string must be always lower than or equal to its permitted range.</p>		
<p>The positive and negative terminals of PV modules must be connected to the positive and negative DC input terminals of the inverter respectively.</p>		
<p>During the installation of PV strings and the inverter, the positive or negative terminals of PV strings cannot be connected with short circuit.</p>		

5.3.1 Preparation

Route collecting for the installation of PV strings and inverter.

Input Route	Number of Input Route
1	Connected to any route
2	Connected to route 1 & 3
3	Connected to route 1, 2 & 3

PV Strings DC input cable and connectors have been prepared; Table 5.2 lists the recommended outdoor copper-core DC input cable specifications.

Cable	Cable type	Cross-sectional Area (mm ²)		Cable Outer Diameter (mm)
		Range	Recommended Value	Range
DC cable	common PV cables in the industry (model: PV1-F)	4~6	4	5~8

Table 5.2 Recommended DC input cable recommended specifications

- Connectors of PV Strings: Positive and negative DC input connectors are used, as shown in Figure 5.8 and Figure 5.9.

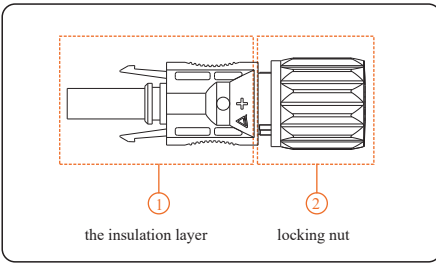

Figure 5.10 Positive connector compositions

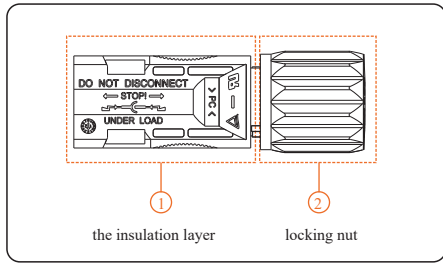



Figure 5.11 Negative connector compositions

 <p>NOTE</p>	<p>Positive and negative metal connectors are packed with positive and negative connectors respectively when shipped out. After unpacking, keep the positive and negative ones separate to avoid confusion.</p>
-------------------------------------------------------------------------------------------------	-----------------------------------------------------------------------------------------------------------------------------------------------------------------------------------------------------------------

- Procedures of connecting the PV Strings

Step 1 Remove an appropriate length of the insulation layer from the positive and negative power cables using a wire stripper, as shown in below Figure.

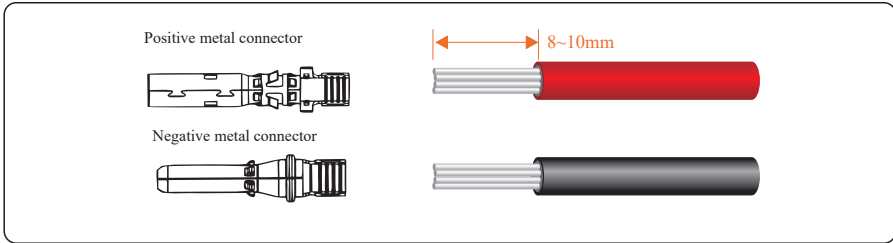

Figure 5.12 Removing insulation layer for DC cable (unit: mm)

Step 2 Insert the exposed areas of the positive and negative power cables into the metal terminals of the positive and negative connectors respectively and crimp them using a crimping tool, as shown in Figure 5.13.

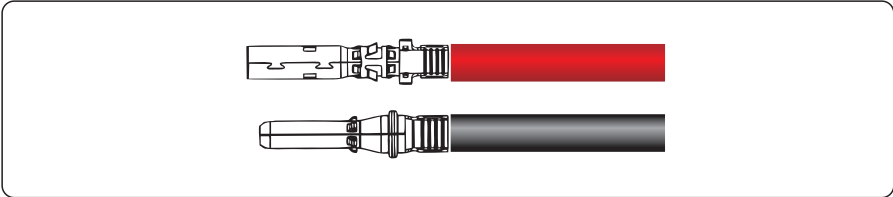

Figure 5.13 Crimping a metal connector

Step 3 Insert the crimped positive and negative power cables into the corresponding positive and negative connectors until a "click" sound is heard, as shown in Figure 5.14.

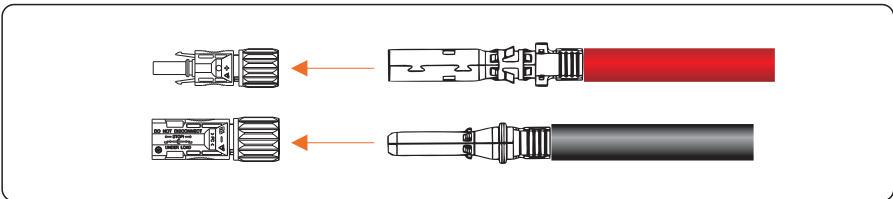

Figure 5.14 Connecting positive and negative connectors

Step 4 Tighten the locking nuts on the positive and negative connectors using a removal wrench, as shown in Figure 5.15.

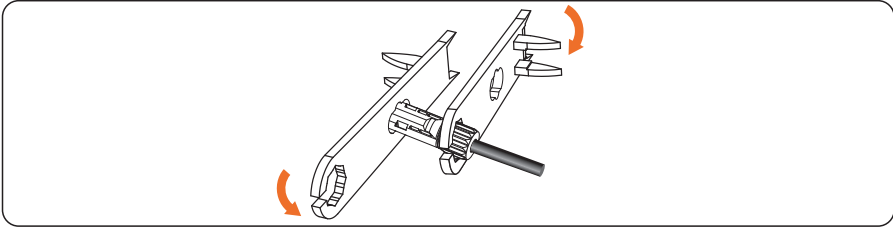

Figure 5.15 Locking connectors

Step 5 Measure the voltage of every route Strings using a multimeter. Ensure that the polarities of the DC input power cables are correct, as shown in Figure 5.16.

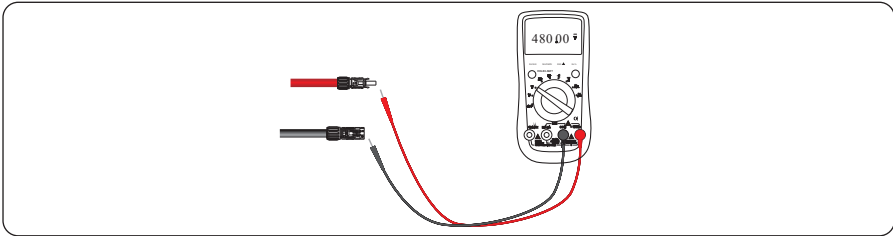

Figure 5.16 Checking the voltage of every route Strings

Step 6 Insert the positive and negative connectors into their corresponding terminals of the inverter until a "click" sound is heard, as shown in Figure 5.17.

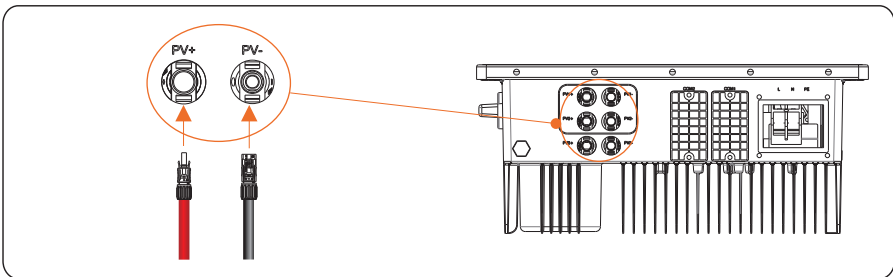
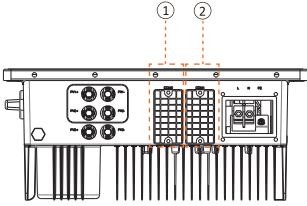

Figure 5.17 Connecting to the inverter

Step 7 After connecting the PV strings, ensure that all connectors are in position by checking or resistance when a slight pull is applied.

5.4 Connecting Communication Cables

5.4.1 Communication Mode Description



Number	Description
①	COM2(RS485/meter/CT/DI)
②	COM1(WIFI/GPRS/Ethernet/ RS485)

You can use the following communication modes to implement communication: Bluetooth, WIFI, GPRS and RS485 all of which are described as follows.

- **Bluetooth Module**

You can turn on the Bluetooth function of the mobile phone, and set parameters and monitor data of the inverter through the mobile APP. For details about operation, refer to APP User Manual.

- **WIFI & GPRS & RS485 Modules**

Following figure show inverter’s interface to connect WIFI, GPRS and RS485 accessory, please refer user manual of accessory for connecting method and its setting.

5.4.2 RS485 Installation

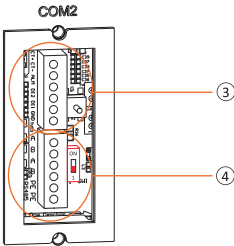

Number	Description
③	For CT/DRM
④	For RS485 connection

The multiple inverter network and RS485 communication is as follows:

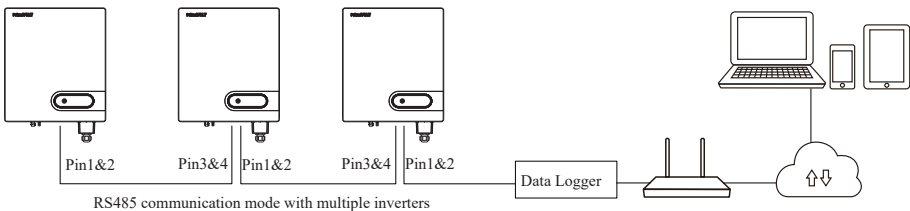

Install RS485 following this steps:

Step1 Loosen screws and remove the cover plate.

Step2 Wires making, threading and wiring.

Step3 Insert the 6-Pin terminal into the RS485 communication port.

Step4 Install the RS485 cover.

Step5 RS485 communication address setting.

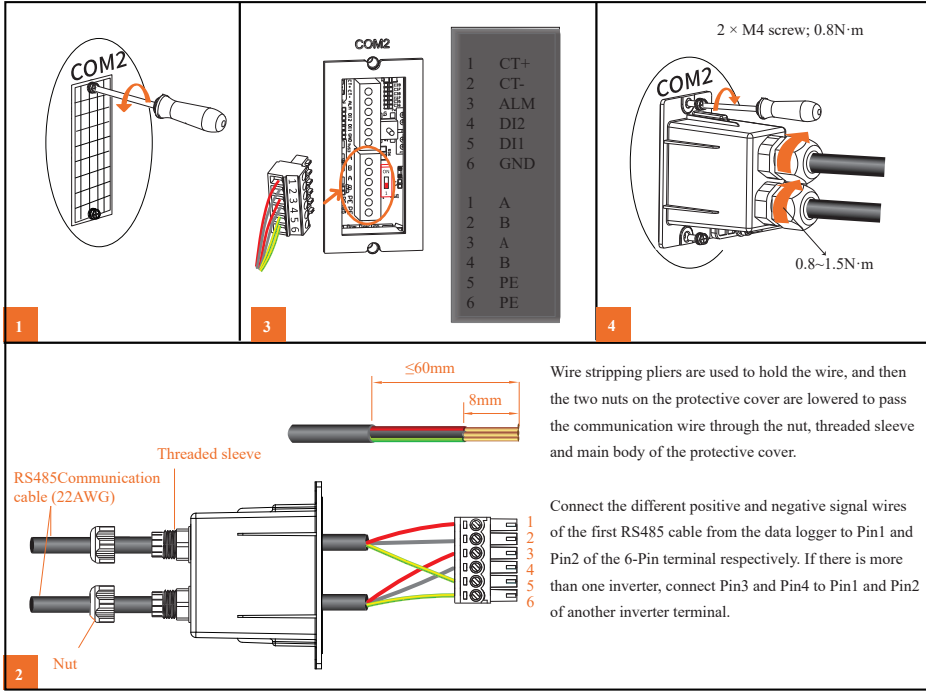

①Download the APP in either of the following ways

- Scan the QR code on the inverter to download the APP
- Download the APP from the APP store or Google Play.

Note: You need to grant all access rights in all pop-up windows when installing the APP or setting your phone.

②Power on the inverter.

③Connect the inverter. Open the bluetooth on your phone, then open the APP. Then follow the instructions below:

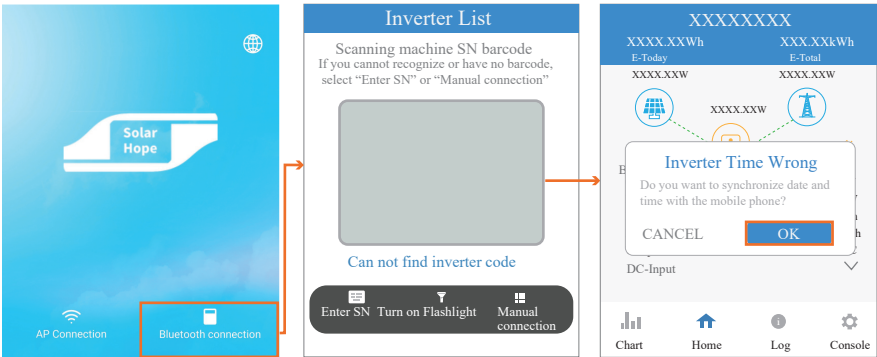

④ Go to Console>Communication Setting > RS485 Setting > Modbus Page, check the Modbus address (the default value is 1),and click to modify the address as required if necessary.

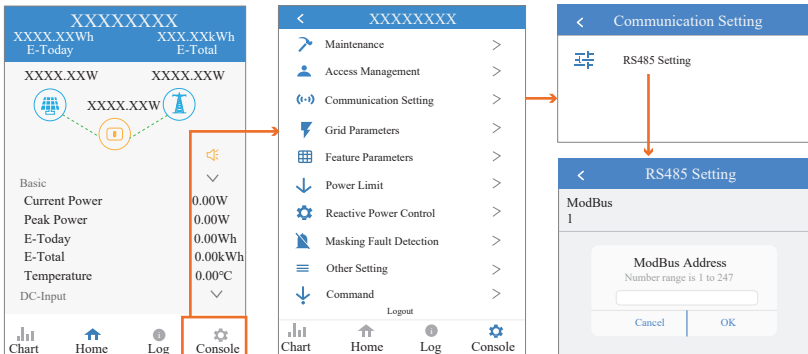

5.4.3 Country code configuration (only for Administrator)

Go to [Console > Grid Parameters](#) page. Follow the steps below to configure the country code for Australia only for Administrator status.

The screenshot shows the 'Grid Parameters' configuration screen. The 'Standard Code' is set to 'AU (AS/NZS4777.2:2020 Australia A)'. Other parameters include delay times and power gradients. A note at the bottom states: 'Note: Standard Code can be selected under Administrator mode only.'

Note:

For Australian Market: Region settings must be selected during commissioning. To comply with AS/NZS 4777.2:2020. Please contact your local electricity grid operator on which region to select.

- **Note on Regional Safety Settings**

Regional Safety Setting is a mandatory selection when configuring the system—the system will not operate if it is not selected. You may be prompted to update the inverter software. Do this if requested. For convenience the Regional Safety Settings are set by selecting the Region from the list provided in the app. The list is maintained with the latest settings required by AS4777.2:2020. Selection of a region automatically selects Power Quality Response Mode settings, including:

- Voltage balance mode (where available)
- Voltage and frequency limits
- Sustained operation for frequency variations
- Grid Protection
- Power Rate Limits
- Frequency Response Limits
- Voltage Disturbance Withstand
- Volt-Var response
- Volt-Watt response
- Fixed Power Factor Mode
- Reactive Power mode

Note

The local grid operator may request a non-standard safety setting for an installation. If no, contact our company for assistance in changing settings.

5.5 Power limit (optional)

5.5.1 Wiring diagram of Inverter+CT

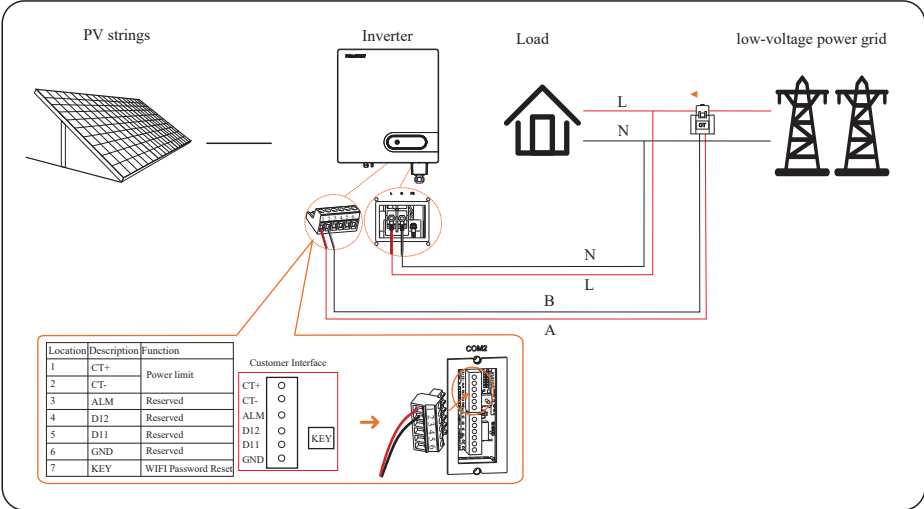

Figure5.18 Wiring diagram of Inverter+CT

- Set “Power control” function to “CT sensor”
- Set “Meter location” function to “On Grid”
- Set “Power flow direction” function to “From grid to inverter”
- Set “maximum feed-in grid power” if needed

<
Power Limit

Power control

CT sensor

Meter location

On Grid

Power flow direction

From grid to inverter

Maximum feed in grid power(W)

0

Figure 5 19 Settings via APP

5.5.2 Wiring diagram of Inverter+Meter

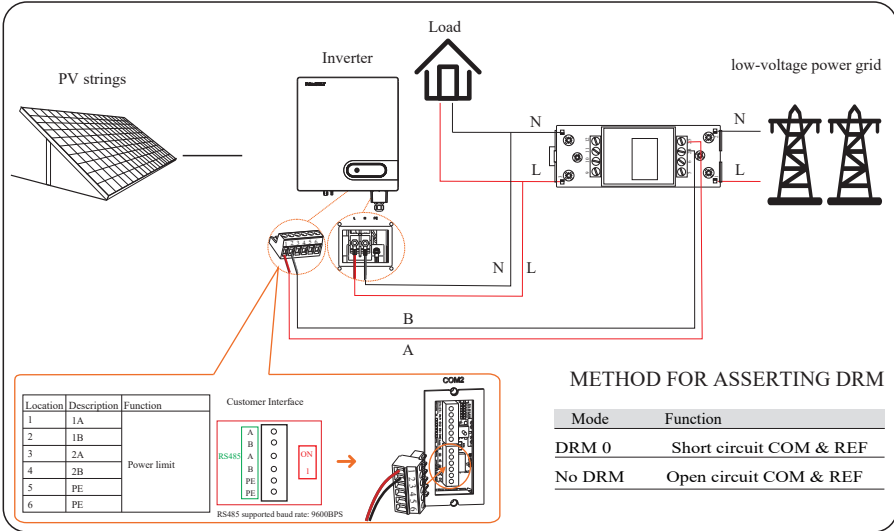

Figure5.20 Wiring diagram of Inverter+Meter

- Set the “Power control” function to “Digital Power Meter”
 - Set “Meter location” function to “On Grid”
 - Set “Meter Type”
 - Set “Power flow direction” function to “From grid to inverter”
 - Set “Digital meter Modbus address”
 - Set “Maximum feed-in grid power” if needed
- When “Power Control” is set to “Digital Power Meter”, the RS485 of inverter will change to a Host that will communicate with digital meter using ModbusRTU Protocol (9600 BPS, 8 data bit, 1 stop bit, no parity data format) through communication address 1. Please make sure that the meter is set to Modbus-RTU, 9600, 8-N-1 with address 1. For details of digital meter setting operation, please refer to the meter user manual.

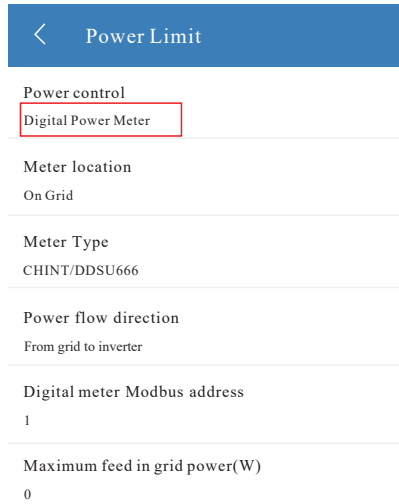

Figure5.21 Settings via APP

5.6 GPRS/WIFI/LAN Module Connection

For details, please refer to the corresponding Module Installation Guide in the packing.

6 Startup/Shutdown Procedure

6.1 Check before startup/shutdown Procedure

Check following this steps after installation.

No.	Items
1	The inverter is firmly installed.
2	There is enough heat dissipation space, no external objects or parts left on the inverter.
3	It is convenient for operation and maintenance.
4	The wiring of the system is correct and firm.
5	Check whether the DC and AC connections are correct with a multimeter, and whether there is a short circuit, break, or wrong connection.
6	Check whether the waterproof nuts of each part are tightened.
7	The vacant ports have been sealed; all gaps at the cable inlet and outlet holes have been plugged with fireproof/waterproof materials, such as fireproof mud.
8	All safety labels and warning labels on the inverter are complete and without occlusion or alteration.

6.2 Startup Procedure

Supply Main Switch

See if there's any on site
(The figure is only for reference)

①

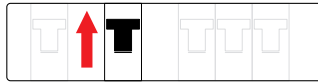

AC Circuit Breaker

Switch to ON
(The figure is only for reference)

②

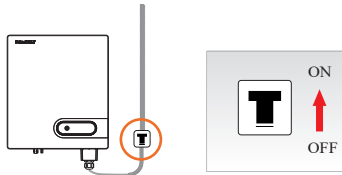

PV Switch

Switch to ON

③

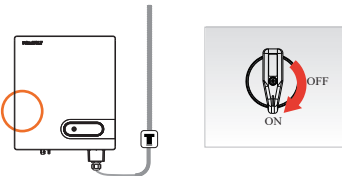

LED icon

Blue on (normal status)

④

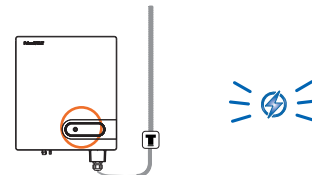

Finishing

⑤

Your system has been started up

6.3 Shutdown Procedure

It may be necessary to shut down the inverter sometimes during the daily use. If necessary, please follow the procedures:

Supply Main Switch
See if there's any on site
(The figure is only for reference)



AC Circuit Breaker
Switch to OFF
(The figure is only for reference)

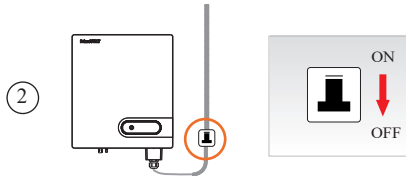

PV Switch
Switch to OFF

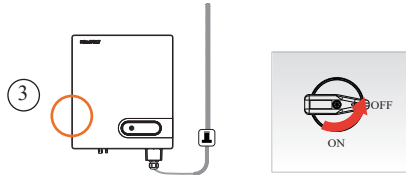

Wait at least 5 minutes
Let inverter discharge to
a safe range.



Finishing **5** Your system has shutdown

 WARNING	After the inverter is powered off, the heat sink generates heat and there is excess electricity in the inverter. To avoid electric shocks and burns, powered off inverter for at least 10 minutes before performing operations.
----------------------------------------------------------------------------------------------------	---------------------------------------------------------------------------------------------------------------------------------------------------------------------------------------------------------------------------------

7 User Interface

Display screen of inverter is composed of LED indicator and (LCD is optional for some models of inverter). Led contains three color states, blue, green and red respectively. For more details, refer to Table 7.1 HMI specification definition.

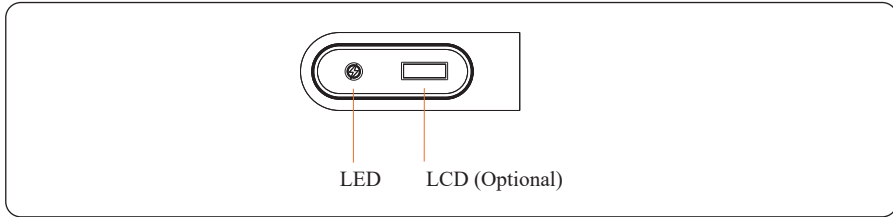

NOTE

You can view & set data of the inverter through inverter APP. For details about operation, refer to APP User Manual. APP User Manual is available for free from website.

7.1 LED

LED Indicator	Description	Status
Blue led	Standby	blink (slowly)
	Normal status	on
Green led	Limited power operation	on
Red led	Refer to the table below	

Status	Details	Warning code
Red led blink (slowly) 1s every times	Grid over voltage	A0 Grid OV
	Grid under voltage	A1 Grid UV
	Grid absent	A2 Grid Loss
	Grid over frequency	A3 Grid OF
	Grid under frequency	A4 Grid UF
Red led blink (quickly) 0.25s every times	PV over voltage	B0 PV OV
	Insulation resistance abnormal (Earth Fault)	B1 Imp abn
	Leakage current abnormal (Earth Fault)	B2 Lkge abn
	Control power abnormal	C0 Powerfail
Red led on	Electric arc abnormal	C1 Arc fault
	DC bias current abnormal	C2 OP Dc OC
	Inverter relay abnormal	C3 RLY abn
	Inverter over temperature	C5 SYS OT
	Leakage current HCT abnormal	C6 LkgCT abn
	System fault	C7 SYS err
	DC link voltage unbalance	C9 Bus UV
	DC-link over voltage	CA Bus OV
	Internal communication error	CB COM err
	Software version incompatibility	CC FW Incomp
	EEPROM fault	CD EEP err
	Sampling inconsistency	CE Inconsis
	Boost circuit abnormal	CG Bst abn
/	Fan abnormal	C8 FAN lock
	Remote off	CN RMT OFF

Table 7.1 Warning Table

Note: If you select a machine with an LCD screen, the warning code will be displayed on the LCD screen. Non-LCD screen models need to enter the app to view the corresponding warning code.

Error warning will be reported and displayed on APP as well, customers can connect to inverter and check warning details on APP.

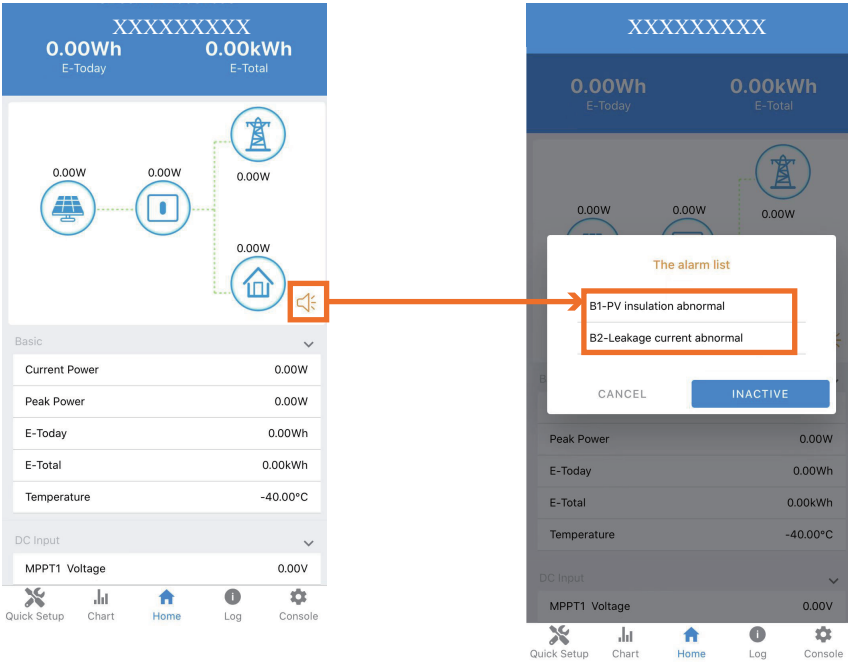

7.2 LCD automatic-page-turning display

Mode	Display content	Note
The LCD display interface of the inverter standby state is shown in the following sequence:		Model name Version
		PV voltage AC voltage
		Today Energy Total Energy
		Warning
The interface of LCD display for countdown of inverter grid connected is shown in the right picture:		Start counter down
The LCD display interface of the inverter grid-connected state is shown in the figure on the right:		Output power Today Energy
		Total Energy Total Hours
		PV voltage PV current
		AC voltage AC current
		hour: minute year/month/day

Table7.2 LCD automatic-page-turning display

8 Maintenance

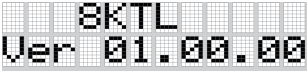
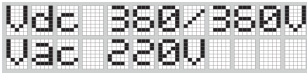
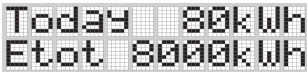
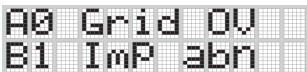
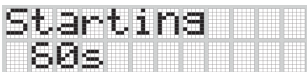
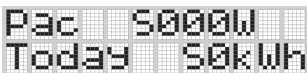
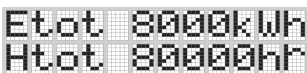
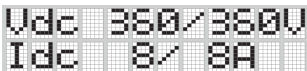
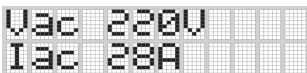
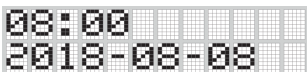

WARNING

Before maintaining and commissioning inverter and its peripheral distribution unit, switch off all the charged terminals of the inverter and wait at least 10 minutes after the inverter is powered off.

8.1 Routine Maintenance

Items	Check Content	Maintain Content	Maintenance Interval
Inverter output status	Statistically maintain the status of electrical yield, and remotely monitor its abnormal status.	NA	Weekly
PV Inverter cleaning	Check periodically and ensure that the heat sink is free from dust and blockage.	Clean periodically the heat sink.	Yearly
PV Inverter running status	Check that the inverter is not damaged or deformed. Check for normal sound emitted during inverter operation. Check and ensure that all inverter communications are running well.	If there is any abnormal phenomenon, replace the relevant parts.	Monthly
PV Inverter electrical connections	Check that all AC, DC and communication cables are securely connected; Check that PGND cables are securely connected; Check that all cables are intact and free from aging.	If there is any abnormal phenomenon, replace the cable or re-connect it.	Semiannually

Table 8.1 Maintenance checklist and interval

8.2 Inverter Troubleshooting

When the inverter has an exception, its basic common warning and exception handling methods are shown below.

Alarm Information	Measures Recommended
A0 Grid OV	<p>1. If the alarm occurs accidentally, possibly the power grid is abnormal accidentally. No extra action is needed.</p> <p>2. If the alarm occurs repeatedly, contact the local power station. After receiving approval of the local power bureau, revise the electrical protection parameter settings on the inverter through APP.</p> <p>3. If the alarm persists for a long time, please confirm that:</p> <ol style="list-style-type: none"> 1) The AC circuit breaker is not tripping frequently (generating an instantaneous high voltage); 2) The wiring of AC cable is followed by the guide in user manual, and high cable impedance can cause a voltage rise on the grid; 3) The voltage of three-phase inverter between the neutral wire and the ground line exceeds 30V; and please correct the grid wiring if it exceeds; <p>If the above problems are excluded, please contact customer service to report a repair.</p>
A1 Grid UV	<p>1.If the alarm occurs accidentally, possibly the power grid is abnormal temporarily. No extra action is needed.</p> <p>2.If the alarm occurs repeatedly, contact the local power station. After receiving approval of the local power bureau, revise the electrical protection parameter settings on the inverter through APP.</p> <p>3.If the alarm persists for a long time, please confirm that:</p> <ol style="list-style-type: none"> 1) The AC circuit breaker is disconnected; 2) The AC circuit breaker is damaged (under closed status, please check that the voltage of the inlet is consistent with that of the outlet); 3) The AC terminals are in good contact. <p>If the actual measuring voltage is within the specified range, please contact customer service to report a repair.</p>
A2 Grid Loss	<p>1. If the alarm occurs accidentally, possibly the power grid is abnormal temporarily. No extra action is needed.</p> <p>2. If the alarm occurs repeatedly, contact the local power station. After receiving approval of the local power bureau, revise the electrical protection parameter settings on the inverter through APP.</p> <p>3. If the alarm persists for a long time, please confirm:</p> <ol style="list-style-type: none"> 1) The AC circuit breaker is disconnected; 2) The AC circuit breaker is damaged (under closed status, please check that the voltage of the inlet is consistent with that of the outlet); 3) The AC terminals are in good contact; 4) Whether the power supply line failure. <p>If exclude all possibilities, please contact customer service to report a repair.</p>
A3 Grid OF	<p>1. If the alarm occurs accidentally, possibly the power grid is abnormal temporarily. No extra action is needed.</p> <p>2. If the alarm occurs repeatedly, contact the local power station. After receiving approval of the local power bureau, revise the electrical protection parameter settings on the inverter through APP.</p>
A4 Grid UF	<p>1. If the alarm occurs accidentally, possibly the power grid is abnormal temporarily. No extra action is needed.</p> <p>2. If the alarm occurs repeatedly, contact the local power station. After receiving approval of the local power bureau, revise the electrical protection parameter settings on the inverter through APP.</p> <p>3. If the alarm persists for a long time, please contact the customer service.</p>
B0 PV OV	<p>Check whether the maximum input voltage of a single PV string exceeds the MPPT working voltage. If yes, modify the number of PV module connection strings.</p>

B1 Imp abn	<ol style="list-style-type: none"> 1. If the alarm occurs accidentally but the inverter can generate power, check whether the installation environment of cables and the components are damp. Please improve the installation environment. 2. If the alarm occurs repeatedly and the inverter can generate electricity occasionally, check whether the positive and negative polarity of the PV component are short-circuited to ground. And check if the component is damaged or the connection cable is broken. 3. If the alarm continues and equipment cannot generate power, please contact customer service to report a repair.
B2 Lkge sbn	<ol style="list-style-type: none"> 1. If the alarm occurs accidentally but the inverter can generate power, probably the power grid causes inverter can be automatically recovered. No extra action is needed. 2. If the alarm occurs frequently and is accompanied by an insulation impedance alarm. Check for the abnormal alarm of the insulation. 3. If the alarm continues and the equipment cannot generate electricity, please contact customer service to report a repair.
C0 Powerfail	<ol style="list-style-type: none"> 1. If the alarm occurs occasionally, the inverter can be automatically recovered. No extra action is needed. 2. If the alarm occurs repeatedly. Please contact customer service.
C1 Arc Fault	If the alarm occurs, the inverter cannot work properly. Please contact customer service.
C2 OP Dc OC	<ol style="list-style-type: none"> 1. If the alarm occurs occasionally, the inverter can be automatically recovered. No action is required. 2. If the alarm occurs repeatedly, the inverter cannot work properly. Please contact customer service.
C3 RLY abn	<ol style="list-style-type: none"> 1. If the alarm occurs occasionally, the inverter can be automatically recovered. No action is required. 2. If the alarm occurs repeatedly, for single-phase inverter, check whether the live line and neutral line on the AC side is reversed. For three-phase inverter, check the voltage of the live line and neutral line to the ground. If the grid side is normal, please contact customer service to report a repair.
C5 SYS OT	<ol style="list-style-type: none"> 1. If the alarm occurs occasionally, the inverter can be automatically recovered. No action is required. 2. If the alarm occurs repeatedly, please check whether the installation site has direct sunlight, bad ventilation, or high ambient temperature (such as installed on the parapet). Yet, if the ambient temperature is lower than 45° C and the heat dissipation and ventilation is good, please contact customer service.
C6 LkgCT abn	<ol style="list-style-type: none"> 1. If the alarm occurs occasionally, it could have been an occasional exception to the external wiring. The inverter can be automatically recovered. No action is required. 2. If it occurs repeatedly or cannot be recovered for a long time, please contact customer service.
C7 SYS err	If the alarm occurs, and the inverter cannot work, please restart the inverter. If the alarm continues, please contact customer service.
C9 Bus UV	<ol style="list-style-type: none"> 1. If the alarm occurs occasionally, the inverter can be automatically recovered. No action is required. 2. If the alarm occurs repeatedly, the inverter cannot work properly. Please contact customer service.
CA Bus OV	<ol style="list-style-type: none"> 1. If the alarm occurs occasionally, the inverter can be automatically recovered. No action is required. 2. If the alarm occurs repeatedly, the inverter cannot work properly. Please contact customer service.

CB COM errr	1. If the alarm occurs occasionally, the inverter can be automatically recovered. No action is required. 2. If the alarm occurs repeatedly, the inverter cannot work properly. Please contact customer service.
CC FW Incomp	1. If the alarm occurs occasionally, the inverter can be automatically recovered. No action is required. 2. If the alarm occurs repeatedly, the inverter cannot work properly. Please contact customer service.
CD EEP err	1. If the alarm occurs occasionally, the inverter can be automatically recovered. No action is required. 2. If the alarm occurs repeatedly, the inverter cannot work properly. Please contact customer service.
CE Inconsis	1. If the alarm occurs occasionally, the inverter can be automatically recovered. No action is required. 2. If the alarm occurs repeatedly, the inverter cannot work properly. Please contact customer service.
CG Bst abn	1. If the alarm occurs occasionally, the inverter can be automatically recovered. No action is required. 2. If the alarm occurs repeatedly, the inverter cannot work properly. Please contact customer service.
C8 Fan abnormal	1. If the alarm occurs occasionally, please restart the inverter. 2. If it occurs repeatedly or cannot be recovered for a long time, check whether the external fan is blocked by other objects. Otherwise, please contact customer service.
CN RMT OFF	If the alarm occurs, please check whether you send the remote shutdown order through APP or remote monitor. If not, please contact the customer service center.

	<p>NOTE</p>	<p>If you cannot clear the preceding alarm according the measures recommended, contact your dealer in a timely manner.</p>
-----------------------------------------------------------------------------------	--------------------	----------------------------------------------------------------------------------------------------------------------------

8.3 Removing the Inverter

Perform the following procedures to remove the inverter:

Step 1: Disconnect all cables from the inverter, including communications cables, DC input power cables, AC output power cables, and PGND cables.

Notes:
When removing DC input connector, insert the removal wrench to the bayonet, press the wrench down, and take out the connector carefully.

Step 2: Remove the inverter from the rear panel.

Step 3: Remove the rear panel.

	<p>WARNING</p>	<p>Before removing DC input connector, double check and ensure DC input switch is turned OFF to avoid inverter damage and personal injury.</p>
-------------------------------------------------------------------------------------	-----------------------	------------------------------------------------------------------------------------------------------------------------------------------------

Appendix

Model	PV 7KTL-D1P	PV 8KTL-D1P	PV 10KTL-D1P
Efficiency			
Max. efficiency	98.2%	98.2%	98.2%
European efficiency	97.4%	97.5%	97.6%
Input (PV)			
Max. PV configuration (STC ¹)	133%		
Max. input voltage (V)	550		
Rated input Voltage (V)	360		
Max. input current (A)	40 (2*20)	50 (2*15+20)	
Max. short circuit current (A)	52 (2*26)	66 (2*20+26)	
Start input voltage (V)	90		
MPPT operating voltage range (V)	60-540		
Max. Number of PV Strings	2 (1/1)	3 (2/1)	
No. of MPPTs	2		
Output (Grid)			
Rated AC active power (W)	7000	8000	10000
Max. AC apparent power (VA)	7700	8800	10000
Max. AC active power (PF=1) (W)	7700	8800	10000
Max. AC output current (A)	35	40	45.5
Rated AC voltage (V)	220/230, L+N+PE		
AC voltage range (V)	160-300 (Adjustable)		
Rated Grid frequency (Hz)	50/60		
Grid frequency range (Hz)	45-55 / 55-65 (Adjustable)		
THDI	<3% (Rated Power)		
DC current injection	<0.5%I _n		
Power factor	>0.99@Rated power (Adjustable 0.8 Leading-0.8 Lagging)		
Inrush Current	90		
Protection			
DC Switch	Support		
Anti-islanding protection	Support		
AC overcurrent protection	Support		
AC short circuit protection	Support		
DC reverse connection	Support		
Surge Arrester	DC Type III (Optional) / AC Type III (Optional)		
Insulation detection	Support		

¹ STC : Standard Test Conditions.

General	
Topology	Transferless
IP rating	IP65
Night Self Consumption	<1W
Cooling	Natural cooling
Operating Temperature Range(°C)	-25~60
Relative Humidity Range	0~100%
Max. Operating Altitude (m)	4000
Noise (dB)	<30
Dimensions (W*H*D)	400mm*450mm*170mm
Weight (kg)	16
HMI & COM	
Display	Wireless & APP+LED, LCD (optional)
Communication interface	WIFI /GPRS (optional)/RS485
Certification	
Safety	IEC62109-1, IEC62109-2
Grid code	IEC61727/62116, ABNT 16149/16150, IEEE 1547, AS4777
Warranty	10 Years

Notes:

- 1) Grid power voltage range can be set according to national voltage standards;
- 2) Power grid frequency range can be set according to national grid standards;
- 3) The preceding technical specifications are subject to change without prior notice. The listed specifications are for your reference only.